



**M Y N A H<sup>SM</sup>**

**TI NITP Driver  
Programmable Serial Interface Card**

**USER MANUAL**

**Rev. P1.16**

**August 14, 2006**

DeltaV is a trademark of Emerson Process Management, Inc © Emerson Process Management, Inc. 1998, 1999.  
All rights reserved.

Printed in the U.S.A.

While this information is presented in good faith and believed to be accurate, Mynah Technologies does not guarantee satisfactory results from reliance upon such information. *Nothing contained herein is to be construed as a warranty or guarantee, express or implied, regarding the performance, merchantability, fitness or any other matter with respect to the products*, nor as a recommendation to use any product or process in conflict with any patent. Mynah Technologies reserves the right, without notice, to alter or improve the designs or specifications of the products described herein.



# 1 INTRODUCTION

## 1.1 Scope

This document is the User Manual for the TI NITP serial communication driver firmware for the Emerson Process Management (EPM) DeltaV Control System; it provides information required to install, configure, and maintain the driver firmware on the DeltaV Programmable Serial Interface Card (PSIC). The reader should be familiar with EPM's DeltaV PSIC and connected TI field devices (supporting the NITP protocol).

The section *Document Format* briefly describes the contents of each section of this manual. *System Specifications* outlines hardware and software requirements for the TI NITP Driver (P1.16) firmware.

## 1.2 Document Format

This document is organized as follows:

<b>Introduction</b>	Describes the scope and purpose of this document.
<b>Theory of Operation</b>	Provides a general functional overview of the TI NITP Driver.
<b>Downloading Firmware</b>	Describes downloading procedures for the TI NITP Driver firmware on to the DeltaV PSIC.
<b>Configuration Information</b>	Describes procedures and guidelines for configuring the DeltaV PSIC.
<b>Operational Check</b>	Provides tips and assistance to ensure PSIC is properly setup and configured.
<b>DeltaV–Field Device Electrical Interface</b>	Describes the electrical interface between DeltaV and the Field Device. Also describes the cable pin assignments for RS-232 and RS-422/485 communications.
<b>Technical Support</b>	Describes who to call if you need assistance.



**1.3 System Specifications**

The following table lists the minimum system requirements for the TI NITP Driver:

**Table 1: System Specifications**

<b>Firmware</b>	TI NITP Driver Firmware (P1.16)
<b>Protocol Compatibility</b>	NITP (Non Intelligent Terminal Protocol), as documented in SIMATIC TIWAY 1, UNILINK Host Adapter User Manual (Manual Assembly number: 2587871-0045), and TBP (Transparent Byte Protocol) as documented in TI User Manual Assembly number: 2589734-0002  NITP is supported as non-ASCII via the UNILINK Adapter and directly to a PLC as ASCII.
<b>Software Requirements</b>	DeltaV System Software (Release 6.3 or later) installed on a hardware-appropriate Windows NT workstation configured as a ProfessionalPlus for DeltaV  Serial Interface Port License (VE4102)
<b>Minimum DeltaV Hardware Requirements</b>	DeltaV Serial Module, Series 2 only  DeltaV M3, M5, M5+ or MD Controller, Power Supply and 8 wide controller carrier



## 2 THEORY OF OPERATION

As part of the serial interface port license, a standard Modbus protocol is installed on the DeltaV PSIC prior to customization. The PSIC needs to be flash upgraded from the Modbus protocol to the TI NITP firmware before operation.

The Programmable Serial Interface Card (PSIC) supports RS-232, RS-422/RS-485 Half Duplex and RS-422/RS-485 Full Duplex communications with external devices. For communications with TI PLC's, any of these methods can be utilized. The electrical connection and communication settings must be configured properly to ensure accurate communication between the PSIC and TI PLC's. These are described in Section 4.1.

This driver runs in Master mode only. In this mode, the driver sends read/write commands to the TI PLC, checks validity of responses received, and updates the corresponding DeltaV PSIC registers. PLC register types available for read and write are as follows:

**Table 2: PLC Registers**

Register Type	Description
X	Discrete Input Packed
Y	Discrete Output Packed
CR	Control Register Packed
WX	Integer Input (Analog Inputs)
WY	Integer Output (Analog Outputs)
V	Integer (Variable Memory)
STATUS	PLC Status

Each PSIC, when loaded with the TI NITP Driver, is capable of communicating with TI PLC's over one or both of its two ports, depending upon your application. The serial driver will communicate with TI PLC's in a point-to-point or multi-drop configuration. When using point-to-point, the RS-232 cable will be connected directly to the communication port of the PLC. When connecting to multi-dropped PLC's, a SIMATIC TIWAY UNILINK Host Adapter (with appropriate PIM) must be used. The following diagram illustrates this:

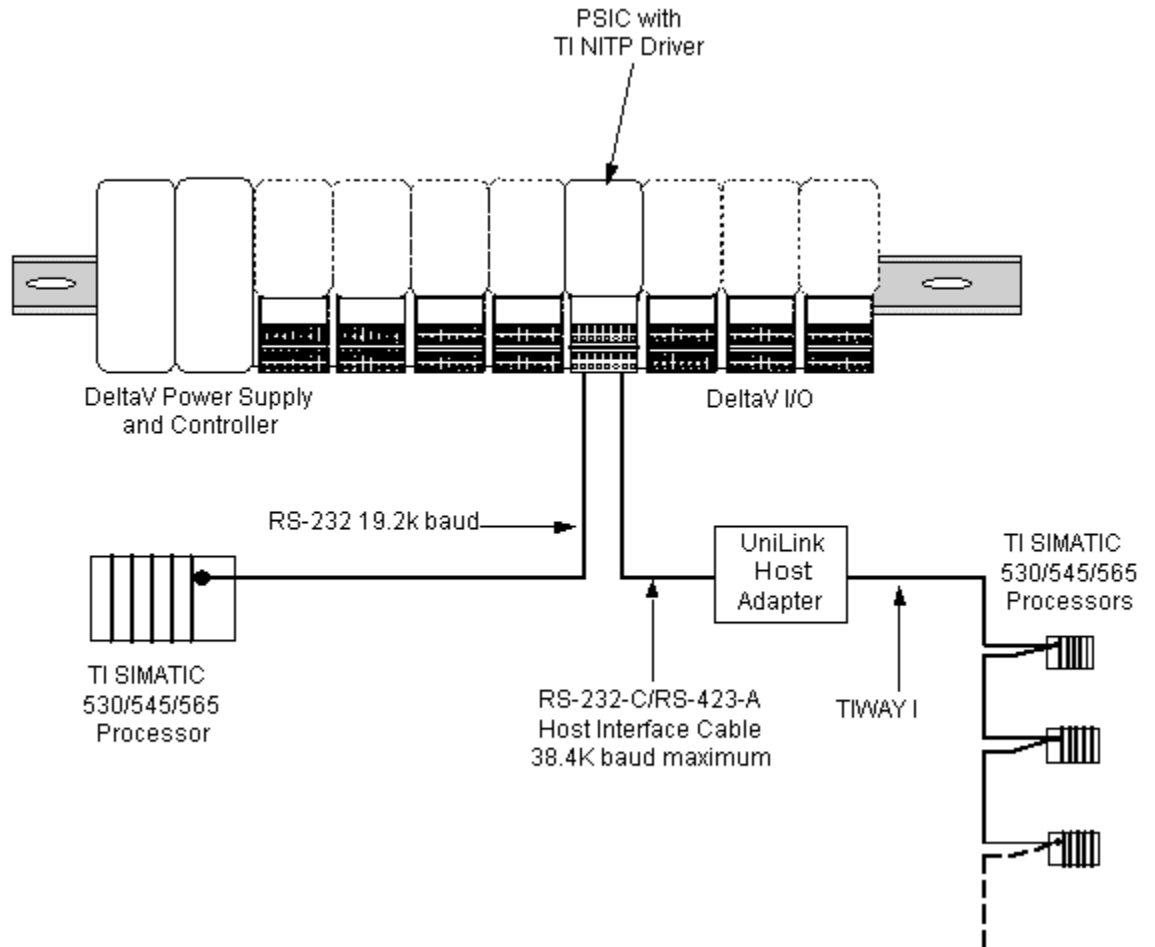



### 3 Downloading the firmware

The DeltaV Controller upgrade utility is used to flash the Serial Card with the distributed firmware.

The driver software comprises 15 files, distributed on a CD. These files must be copied to the DeltaV directory on your ProPlus Workstation. The path is:

**\\DeltaV\ctl\ProgSerial\S2-TiNitp**

The following shows a completed copy operation:

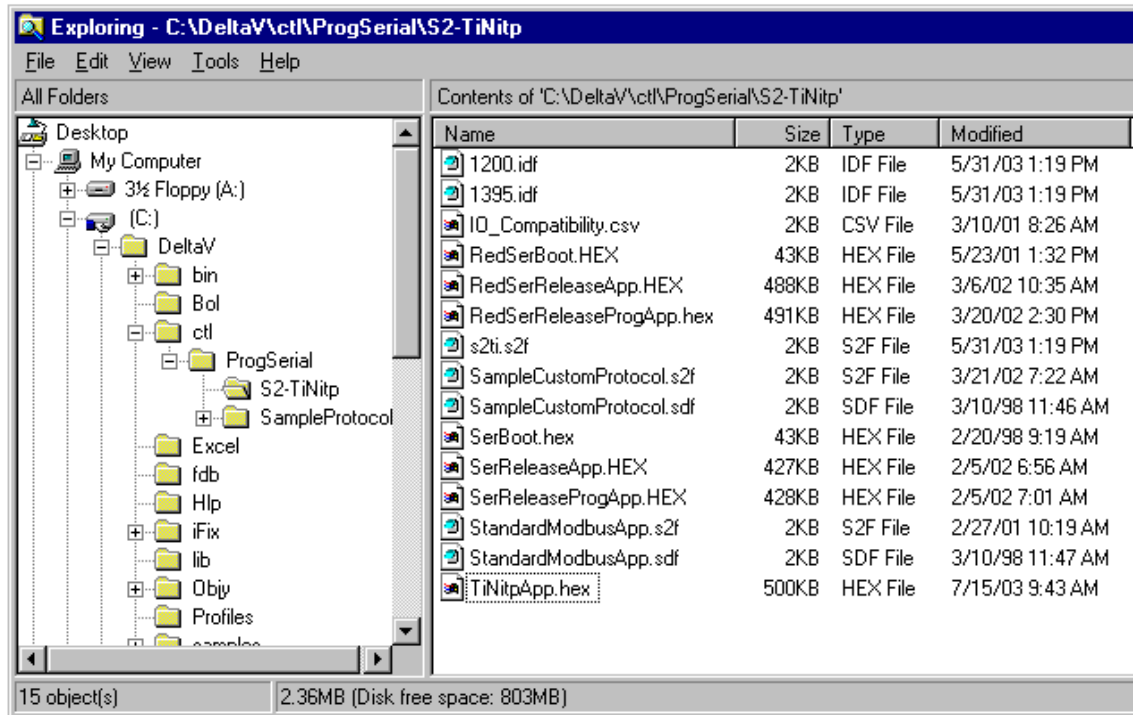

After copy completion, you are ready to program (or upgrade) the Programmable Serial Card with the supplied custom driver software. The steps are as follows:



1. Click on the Start button and select DeltaV-> Installation-> Controller Upgrade Utility as shown below:

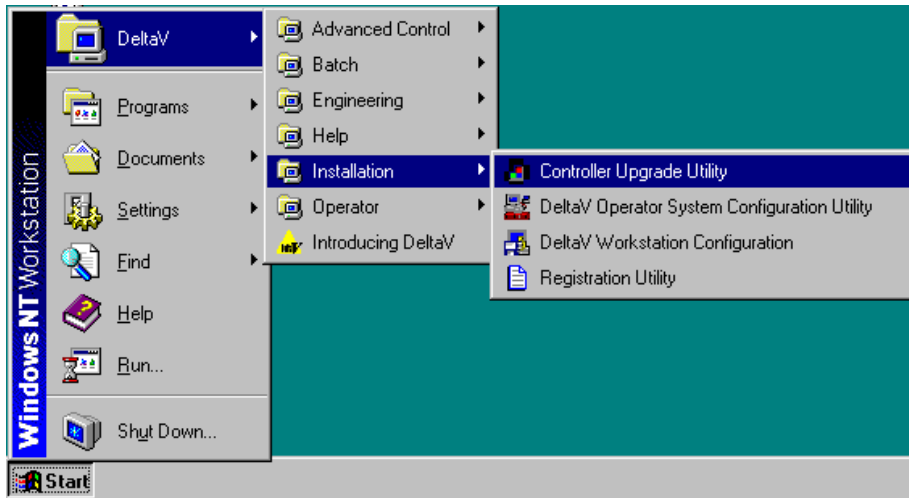

and the following dialog will appear:

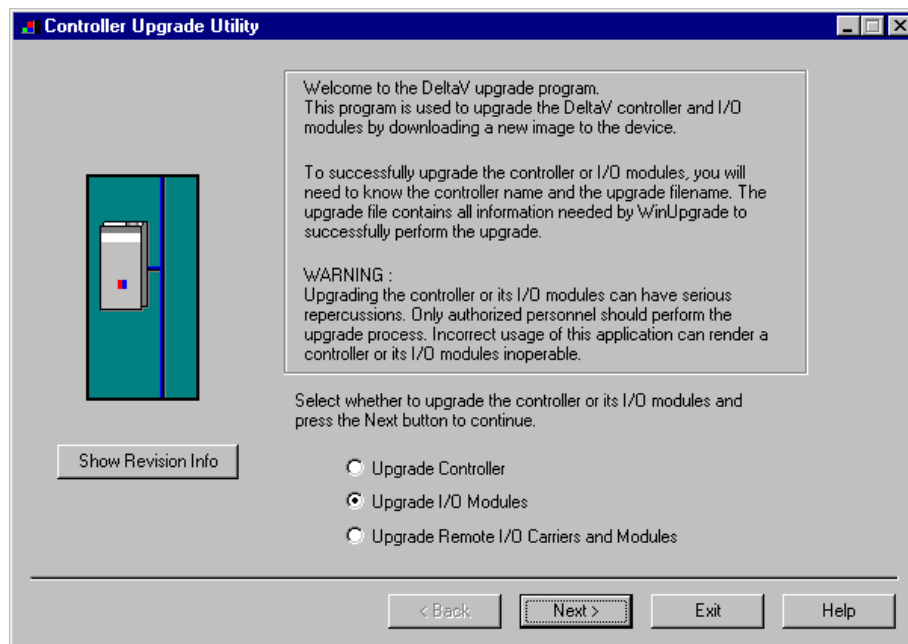



2. Select the Upgrade I/O Modules option as shown above, and then click Next.

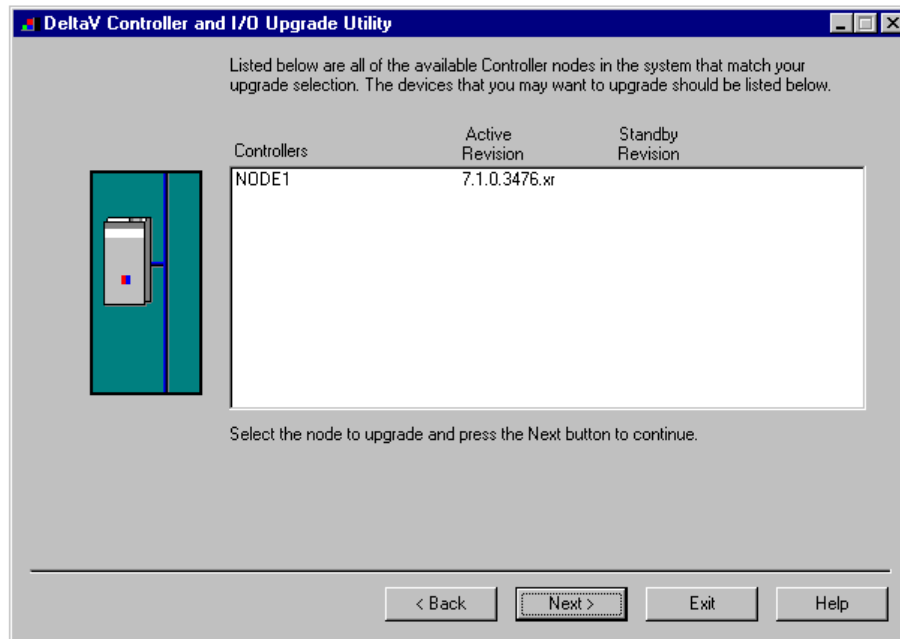

3. The above dialog will appear, listing all the available Controllers in your network.
4. From this dialog, select the appropriate Controller and then Click Next. The dialog with all configured I/O modules will appear as shown below. Your list will be different.

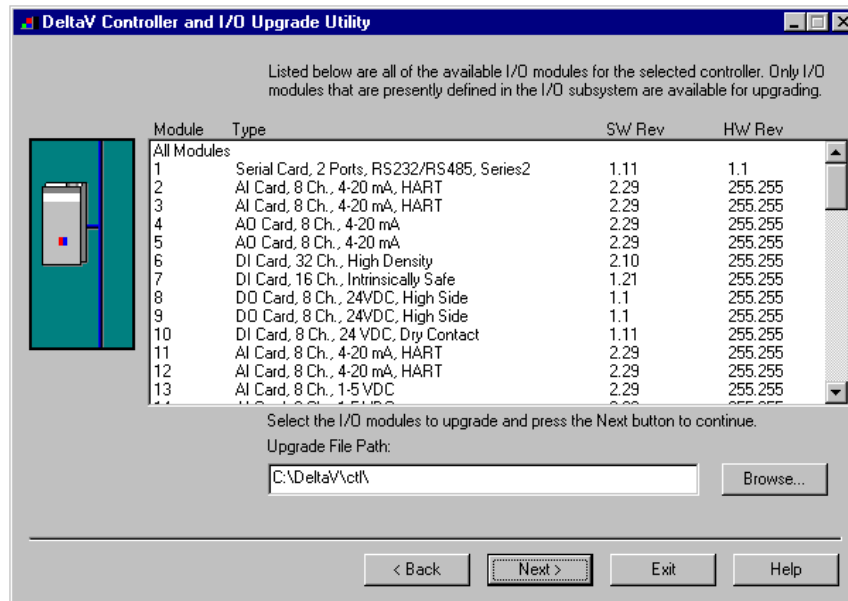



### Note

**The first time a standard Serial card is upgraded to the TI NITP firmware, the dialog will be as shown above. When upgrading an existing Programmable Serial Card, skip Steps 5 and 6, and go to Step 7.**

5. Click the Browse button and select the DeltaV path as shown below. Note that the disk drive could be C or D.

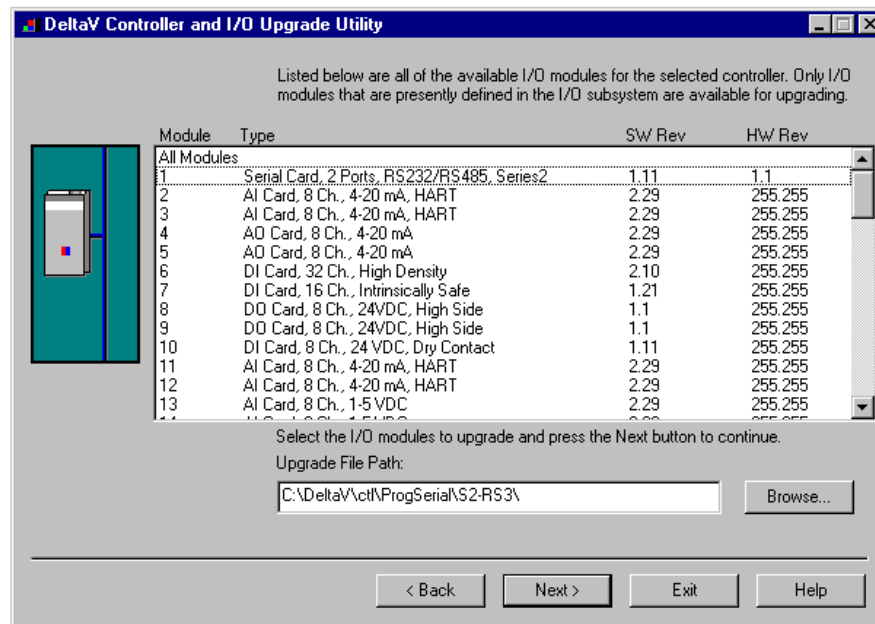

6. Select the Serial module and then click Next. Go to Step 9.
7. If you are upgrading an existing Programmable Serial Card, the dialog will be as shown below. From this dialog, select the Programmable Serial Card I/O Module in the list.

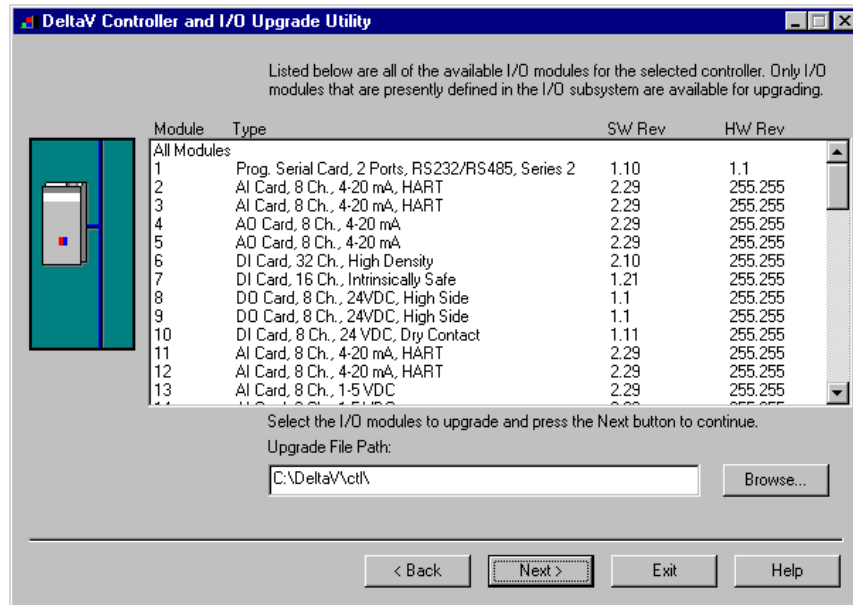

For example, we will select I/O Module 1. This will give you a dialog, from which you will select the file path to where the driver software is located. This path will be:

**\\DeltaVctl\ProgSerial\S2-TiNitp**

Once you are in the specified directory, you will need to select the following file:

**S2TI.S2F**

This is shown in the following dialog.

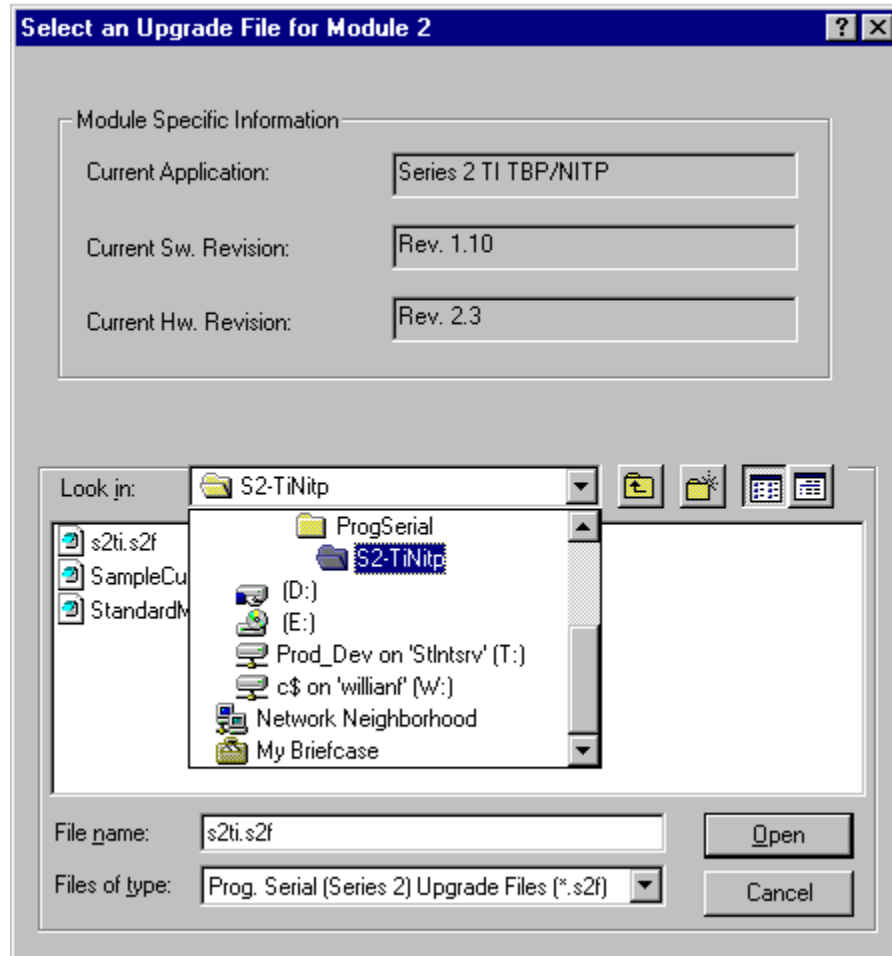

8. After selecting the .S2F file, Click on Open. This dialog will close and you will be back to the following:

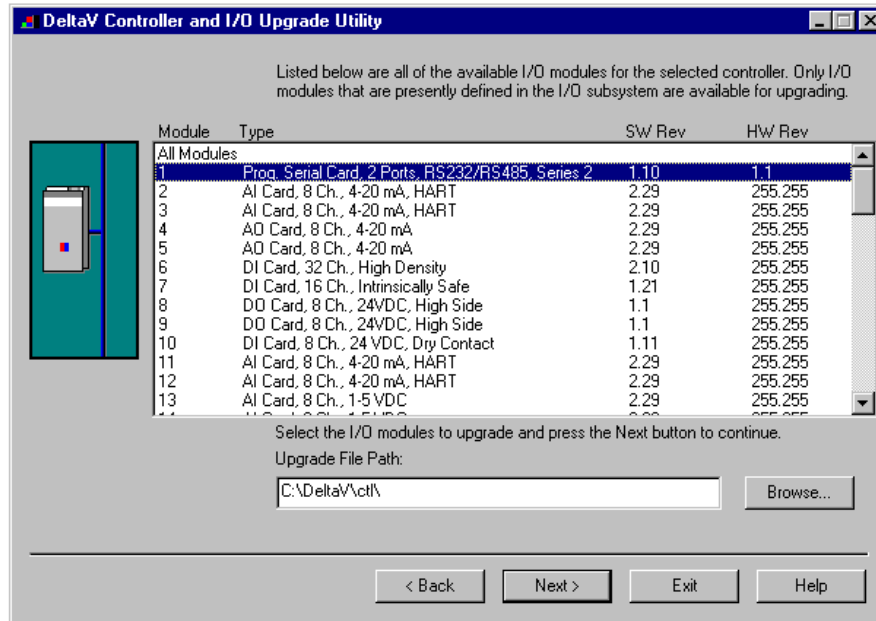

9. In this dialog, Click Next again. You will get the following dialog, confirming the Controller and I/O Module to program.

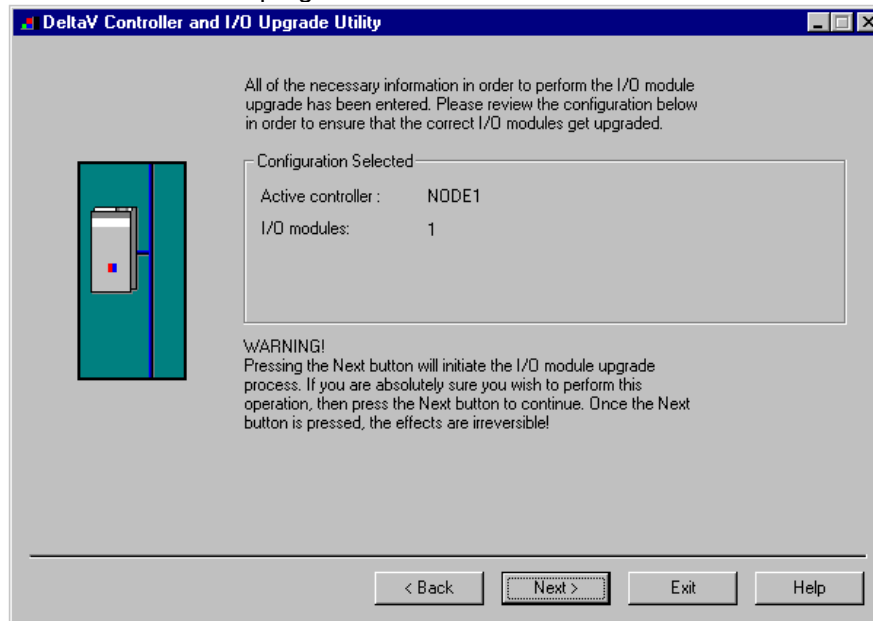

10. Click Next and the I/O Module upgrade process will begin. After completion, you will receive the following dialog, indicating success.

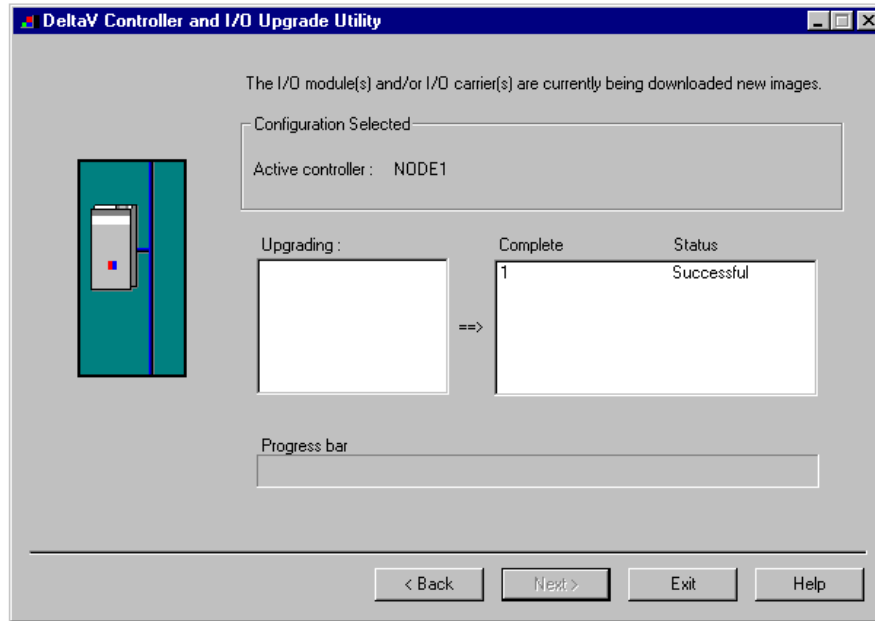

11. This completes the I/O Module upgrade process.



## 4 CONFIGURATION INFORMATION

This section describes the steps necessary to configure the DeltaV PSIC to obtain proper communication.

Each Serial Card in the I/O subsystem contains two channels or ports. Each port will be enabled or disabled individually and each port will contain some port specific configuration parameters. Port configuration comprises RS-232 or RS-422/485, baud rate, parity, byte size, and stop bits used. All selected parameters must match the connected field device(s).

The DeltaV Explorer view of a configuration containing a PSIC will be as follows, where C01 has a card type of Programmable Serial Card, P01 and P02 are the ports on the card, DEVXX are the field devices attached to the ports and DSXX are configured datasets under each device. You can have one or more field devices (each with a unique address) under each port. If a single device is configured, you can use RS-232 or RS-422/485. If configuring more than one, the communications settings must be RS-422/485 to support multi-dropped field devices. Note that the device address (under DEVXX) must match the field device address in point-to-point and multi-dropped communications.

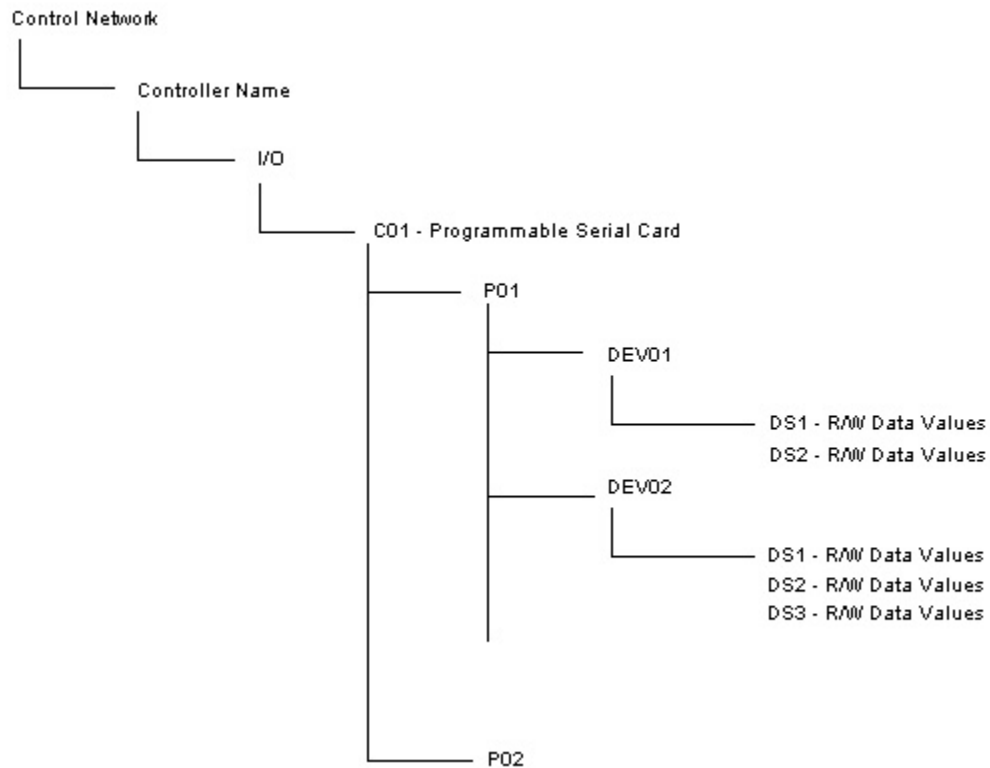

A total of 16 datasets can be configured under each port. The datasets are divided over the configured devices. Each dataset represents a type of data as given in Table 5.



### 4.1 Port Configuration

First, enable the port. Then click on the Advanced Tab and select Master. Specify the retry count, message timeout value in milliseconds, and message delay time. In most cases, you can leave these at their default values. Next, click on the Communications Tab and specify the Port type. The Port type will be RS-232, RS-422/485 Half Duplex (2 wire), or RS-422/485 Full Duplex (4 wire). Select RS-232 for both point-to-point communications, and communications through a Unilink Host Adapter connected to multi-dropped PLC's. Lastly, select the Baud rate, Parity, Data bits and Stop bits parameters; these must match the settings as described below.

For point-to-point, the baud rate is selected via dipswitch settings on the front of the CPU card. For best performance, select this to be 19200. Other RS-232 parameters will be 8-bits, No parity and 1 stop bit. If the PLC has a second RS-485 port, it may be used.

For Unilink Adapter communications, the maximum baud rate is 38400 selected via dipswitches as described below. Other RS-232 parameters will always be 7-bits, Even parity and 1 stop bit.

Unilink Adapter Setup has two switches S1 and S2. Switch S1 determines the Tiway communications parameters, and S2 determines the DeltaV communications.

**Table 3: Dipswitch S1 recommended settings**

Switch	Position	Description
1	UP	NITP
2	UP	NRZI
3	UP	Full Duplex
4	DOWN	Asynchronous
5	UP	MSB of Tiway Baud - 115200
6	UP	Tiway Baud
7	UP	Tiway Baud
8	UP	LSB of Tiway Baud
9	DOWN	Host Command Timeout
10	UP	Host Command Timeout

**Table 4: Dipswitch S2 recommended settings**

Switch	Position	Description
1	UP	Parity Enabled
2	UP	Even Parity
3	UP	Full Duplex
4	DOWN	Asynchronous
5	UP	MSB of Host Baud – 38400
6	UP	Host Baud
7	DOWN	Host Baud
8	UP	LSB of Host Baud
9	DOWN	MHIU/EHA
10	DOWN	Run Mode



## **4.2 Device Configuration**

Specify devices, one for each PLC. The device address must match the PLC address.

## **4.3 Dataset Configuration**

Datasets contain the field values read from a PLC or DeltaV values being written to a PLC. Each dataset will read or write data of one type. This is described in Table 5 below.

### **4.3.1 Data Direction:**

The Data Direction for dataset should be defined as Input or output. This parameter is available only under Master mode.

### **4.3.2 Output Mode:**

Two output modes are available in the DeltaV PSIC: Block Output (0) and Single Value Output (1). In block mode, any register change in the dataset will trigger the entire dataset to be written to the PLC. In single value mode, only the changed register is written out.

The selected mode is dependent on the field device, whether it supports block output or not, and on your specific application. Please refer to the TI PLC documentation. This parameter is available only under Master mode.



**4.3.3 DeltaV Data Type:**

The type of TI register being mapped will determine the Dataset Data Type. This is described in the following table:

**Table 5: TI Register Types**

TI Register Type	Dataset Register Type
X	Boolean with status or Discrete with status 8 bit UINT with status 16 bit UINT with status
Y	Boolean with status or Discrete with status 8 bit UINT with status 16 bit UINT with status
WX	16 bit Int with status or 16 bit Uint with status
WY	16 bit Int with status or 16 bit Uint with status
CR	Boolean with status or Discrete with status 8 bit UINT with status 16 bit UINT with status
V	16 bit Int with status or 16 bit Uint with status
STATUS	16 bit Int with status or 16 bit Uint with status

**4.3.4 DeviceDataType**

The DeviceDataType determines which TI command is being sent to the PLC. This is described in the following table:

**Table 6: TI Register Type Codes**

Device Data Type	TI Type
0	Y – Discrete Output Packed
1	X – Discrete Input Packed
2	WX – Word Input
3	WY – Word Output
4	CR – Control Register
5	V – Variable Memory



6	Status
---	--------

### 4.3.5 Data Start Address and Number of Values

The Start Address for each dataset should be configured to match the TI PLC registers it reads or writes. Note that since the dataset registers are indexed starting with 1, the Start Address must be configured such that (Start Address + 1) is the first TI register being accessed. The following table shows some examples.

**Table 7: Examples of Start Address and Number of Values**

Register Type	Start Address	Number Of Values	First TI Register	Last TI Register
X	0	100	1	100
Y	500	100	501	600
WX	105	50	106	155
WY	300	100	301	400

When the TI Register type is X, Y, or CR, and the DeltaV Data type is Boolean, Discrete, or 8-bit, then there is a one-to-one relationship between the dataset register and the PLC register. However, when the DeltaV Data type is 16-bit, then the driver will pack the TI data, such that each dataset register will represent 16 TI registers. Consequently, dataset start addresses and number of values should be selected carefully. For example, consider the following table:

**Table 8: Calculating Register Number Mapping**

Start Address	Number of Values	TI Register Type	DeltaV Register Type	Description
0	64	X	16-bit UINT	This dataset contains data for 1024 TI X registers (64 * 16). Dataset Register 1 has TI registers 1-16; Dataset register 64 has TI registers 1009-1024.
30	10	X	16-bit UINT	This dataset contains data for 160 TI X registers (10 * 16). First dataset register will be R31. It will contain data for TI registers 481-496. This is calculated as: $((R\# - 1) * 16) + 1$  The last dataset register will be R40. It will contain TI registers 625-640.

The maximum number of values available in the TI PLC varies with the type and model of the PLC. In general, the following are the supported maximums with this revision of the driver.



**Table 9: Maximum allowed Register numbers**

<b>PLC Register Type</b>	<b>DeltaV Register Type</b>	<b>Maximum Values</b>
X, Y, CR	Boolean, Discrete, 8-Bit INT, and 8-Bit UINT	1024
X, Y, CR	16-Bit INT, 16-Bit UINT	64
WX, WY, V	16-Bit INT, 16-Bit UINT	1024

Values outside these ranges will return an error in the driver.

**4.3.6 Special Data 1-5**

The Special Data 1 register is used to select NITP communications (via Unilink Adapters), or point-to-point communications direct to the PLC using TBP or NITP ASCII. The values are as below:

**Table 10: Protocol Selection**

<b>Value</b>	<b>Description</b>
0	NITP (Non-Intelligent Terminal Protocol) to Unilink Adapter
1	TBP (Transparent Byte Protocol) direct to PLC
2	NITP ASCII direct to PLC

Special Data 2-5 are not used. Leave these with default value of 0.



## 5 Operational Check

### 5.1 Scope

The following sections provide some assistance to ensure the interface is working properly.

### 5.2 Verify Hardware and Software Version Number

The user can verify that the TI NITP driver has been installed using the DeltaV Diagnostics tool. The Diagnostics tool will show the Hardware Revision No. (HwRev) and the Software Revision No. (SwRev).

To begin the DeltaV Diagnostic tool select Start-> DeltaV-> Operator-> Diagnostics. In the Diagnostics tool expand the Controller, I/O and then double click on the Programmable Serial Interface Card that has the driver installed.

The following information will be displayed:

:	:	:
HwRev	Hardware Revision	2.3 (or later)
SwRev	Software Revision	P1.16 (or later)

### 5.3 Verify Configuration

- Verify port configuration: The serial port must be enabled. User needs to make sure communication settings such as baud rate, parity, and number of data bits match the field device settings.
- Verify dataset configuration: The datasets configured must be as shown above.

### 5.4 Verify I/O Communication With Control Studio

User can create I/O modules in the control studio to verify correct values are read from the PSIC. For AI and DI data, the values should be changed in the field device and verified that the new data are correctly reported in DeltaV. Similarly, verify that the AO and DO data is being written correctly from DeltaV to the field device.

### 5.5 Using Diagnostics

- Verify PSIC communication: Select the PSIC on Diagnostics and press the right mouse button. Select Display Real -Time Statistics from the drop down menu. If the Programmable Serial Interface Card is functioning then the user will see the Valid Responses counter and the Async and/or Sync Transactions counters incrementing. There will not be any error counting up.
- Verify port statistics: Select the Port on the Programmable Serial Interface Card and press the right mouse button. Then select Display Port Statistics form the drop down menu. Verify that the port communications statistics are being displayed properly and are counting as expected for the protocol's functionality.



- Verify dataset values: Select a dataset and press the right mouse button. Select View Dataset Registers from the Drop down window. Verify that the dataset values are displayed as expected.

## **5.6 LED Indication**

The Yellow LED for the port should be on solid when all communications on that port are valid. The Yellow LED should be blinking if there is some valid communications and some communications with errors on that port. The Yellow LED should be OFF if there are no valid communications on that port.



## **6 DeltaV–Field Device Electrical Interface**

The electrical interface between DeltaV and field devices conforms to the RS-232 and RS-422/485 standards.

Each PSIC has 2 ports, which function independently. The distance between the serial card and the field device can be as much as 4000 feet, per the RS-422/485 standard. When using RS-232, the distance is limited to 50 feet. Section 6.1 shows the pin assignments for the PSIC serial terminal block.

### **6.1 Pin Assignments for DeltaV PSIC**

#### RS-232 Standard

<b>Terminal Number</b>	<b>Signal Description</b>
1	Port 1 - Isolated Ground (GND)
2	Unused
3	Port 1 – Transmit Data (TxD)
4	Unused
5	Port 1 – Receive Data (RxD)
6	Unused
7	Port 1 – Data Terminal Ready (DTR)
8	Port 1 – Data Set Ready (DSR)
9	Port 2 - Isolated Ground (GND)
10	Unused
11	Port 2 – Transmit Data (TxD)
12	Unused
13	Port 2 – Receive Data (RxD)
14	Unused
15	Port 2 – Data Terminal Ready (DTR)
16	Port 1 – Data Set Ready (DSR)

For additional detail, please refer to DeltaV Books Online.



## 6.2 Wiring Connections

In general, the figure below shows the connections between the Field Device and the PSIC termination block for Port 1. In some cases, RxD and TxD signals need to be swapped to create a NULL cable. This can be done easily at the PSIC termination block.

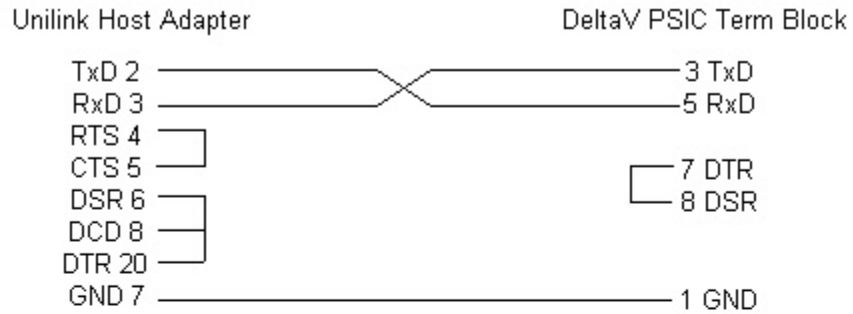

Figure 6.1 Cable Pinout when connecting to a Unilink Host Adapter

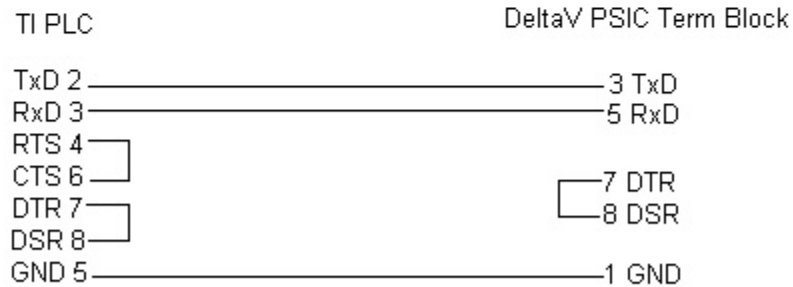

Figure 6.2 Cable Pinout when connecting directly to a TI PLC



## **7 Technical Support**

For technical support or to report a defect, please give Mynah Technologies a call at (636) 681-1555. If a defect is discovered, please document it in as much detail as possible and then fax your report to us at (636) 681-1660.

You can also send us your questions via e-mail. Our address is:

[support@mynah.com](mailto:support@mynah.com)

Thank you for using DeltaV.