



M Y N A HSM

**Orbital 1600ES Driver for DeltaV
Programmable Serial Interface Card
Series 2**

USER MANUAL

Rev. P1.11

September 22, 2005

DeltaV is a trademark of Emerson Process Management © Emerson Process Management 1998, 1999. All rights reserved.

Printed in the U.S.A.

While this information is presented in good faith and believed to be accurate, MYNAH Technologies does not guarantee satisfactory results from reliance upon such information. *Nothing contained herein is to be construed as a warranty or guarantee, express or implied, regarding the performance, merchantability, fitness or any other matter with respect to the products*, nor as a recommendation to use any product or process in conflict with any patent. MYNAH Technologies reserves the right, without notice, to alter or improve the designs or specifications of the products described herein.

1 INTRODUCTION

1.1 Scope

This document is the User Manual for the Series 2 Orbital 1600ES serial communication driver firmware for the Emerson DeltaV Control System; it provides information required to install, configure, and maintain the Orbital 1600ES driver firmware on the DeltaV Series 2 Programmable Serial Interface Card (PSIC). The reader should be familiar with Emerson's DeltaV controller system and the 1600ES Equipment.

The section *Document Format* briefly describes the contents of each section of this manual. *System Specifications* outlines hardware and software requirements for the Orbital 1600ES (P1.11) firmware. *Related Documents* lists other documents used to prepare this manual.

1.2 Document Format

This document is organized as follows:

Introduction	Describes the scope and purpose of this document.
Theory of Operation	Provides a general functional overview of the Orbital 1600ES Driver.
Downloading Firmware	Describes downloading procedures for the Orbital 1600ES Driver firmware on to the DeltaV PSIC.
PSIC Configuration	Describes procedures and guidelines for configuring the DeltaV PSIC.
Driver Communications	Describes Orbital 1600ES commands used and DeltaV Registers containing data.
Operational Check	Provides tips and assistance to ensure PSIC is properly setup and configured.
DeltaV – 1600ES Electrical Interface	Describes the electrical interface between DeltaV and the 1600ES. Also describes the pin assignments for RS-232 communications.
Technical Support	Describes who to call if you need assistance.

1.3 System Specifications

The following table lists the minimum hardware requirements for the Orbital 1600ES Driver:

Table 1: System Specifications

Firmware	Orbital 1600ES Driver Firmware (P1.11)
Protocol Compatibility	Orbital 1600ES Continuous Output data supplied by customer.
Software Requirements	DeltaV System Software (Release 6.3.2 or later) installed on a hardware-appropriate Windows NT workstation configured as a ProPlus for DeltaV Serial Interface Port License (VE4102)
Minimum Hardware Requirements	FRSI DeltaV PSIC Hardware PN: 12P2506X022 FRSI DeltaV M3, M5, MD or Series 2 MD Controller, Power Supply and 2 wide controller carrier FRSI 8 wide I/O card carrier 1600ES devices

2 THEORY OF OPERATION

As part of the serial interface port license, a standard Modbus protocol is installed on the DeltaV PSIC prior to customization. The PSIC needs to be flash upgraded from the Modbus driver to the Orbital 1600ES driver before operation.

The RS-232 communication settings must be configured properly to ensure accurate communication between the PSIC and 1600ES devices. RS-422/485 may be used if the 1600ES devices support this electrical standard. Two 1600ES devices can be connected to a PSIC simultaneously, one on each port. This driver functions as a slave only. In slave mode, this driver communicates with the 1600ES by simply receiving the continuous output of data. This output contains the analyzer information, which is reported to DeltaV via dataset registers.

In general, the primary functions of the driver are listed below:

- Performs data and message handling between DeltaV and 1600ES devices.
- Checks validity of messages received from the 1600ES devices.
- Update dataset register status and data block status to indicate the communication state.
- There are 32 ports in a 1600ES device. Each port can be user selected to provide data. The data comprises date, time, and the 4-analyzer values for Carbon Dioxide, Nitrogen, Oxygen and Argon. The port number is used as the dataset register number in DeltaV. For example, data from port 20 will be found in register 20 of each dataset.

The PSIC dataset architecture employed for each 1600ES is as follows:

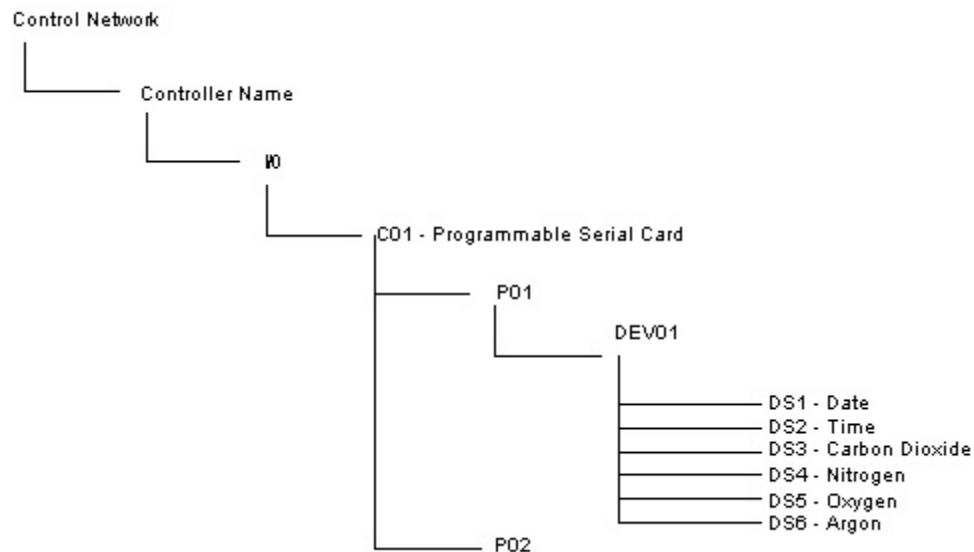

3 Downloading the firmware

The driver software comprises 15 files, distributed on a CD. These files must be copied to the DeltaV directory (you must create the directory first) on your ProPlus Workstation. The path is:

\\DeltaV\ctl\ProgSerial\S2-1600ES

The following shows a completed copy operation:

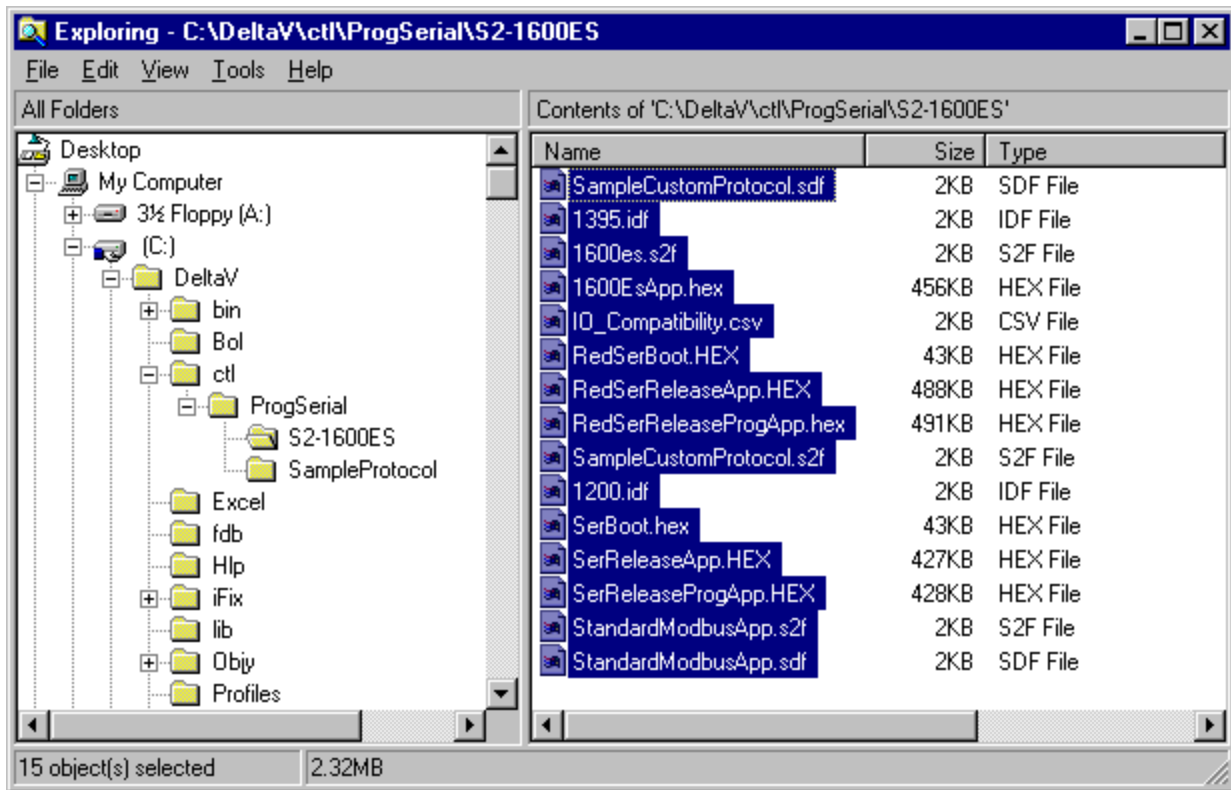

After copy completion, you are ready to program (or upgrade) the Programmable Serial Card with the supplied custom driver software. The steps are as follows:

1. Click on the Start button and select DeltaV, Installation, Controller Upgrade Utility as shown below.

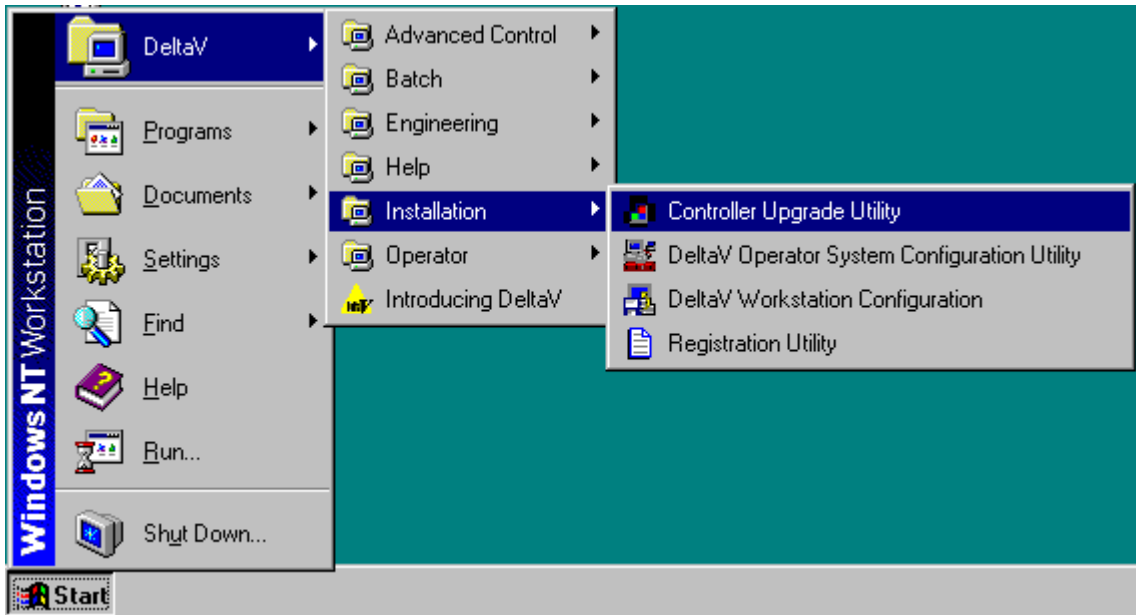

The following dialog will appear:

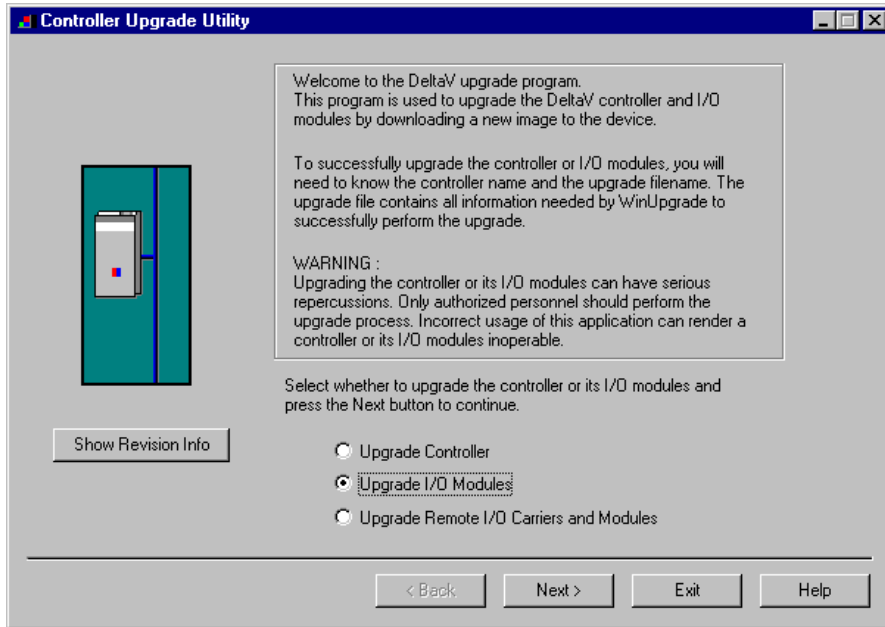

Click on the Upgrade I/O Modules radio button as shown, and then click Next.

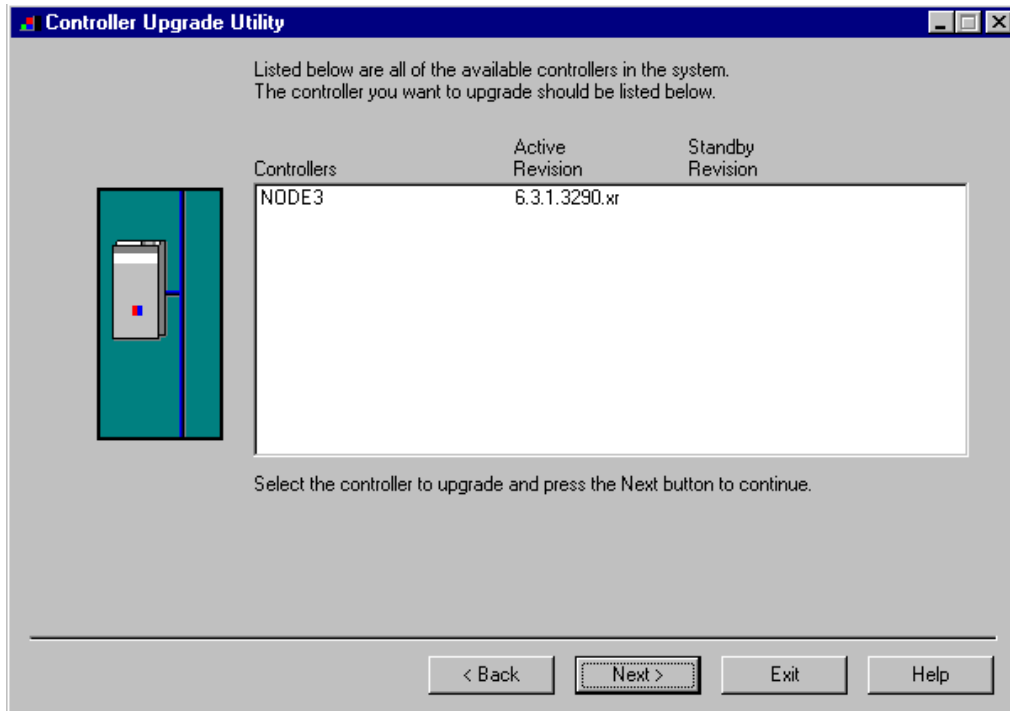

The above dialog will appear, listing all the available Controllers in your network. From this dialog, select the appropriate Controller and then Click Next as shown below.

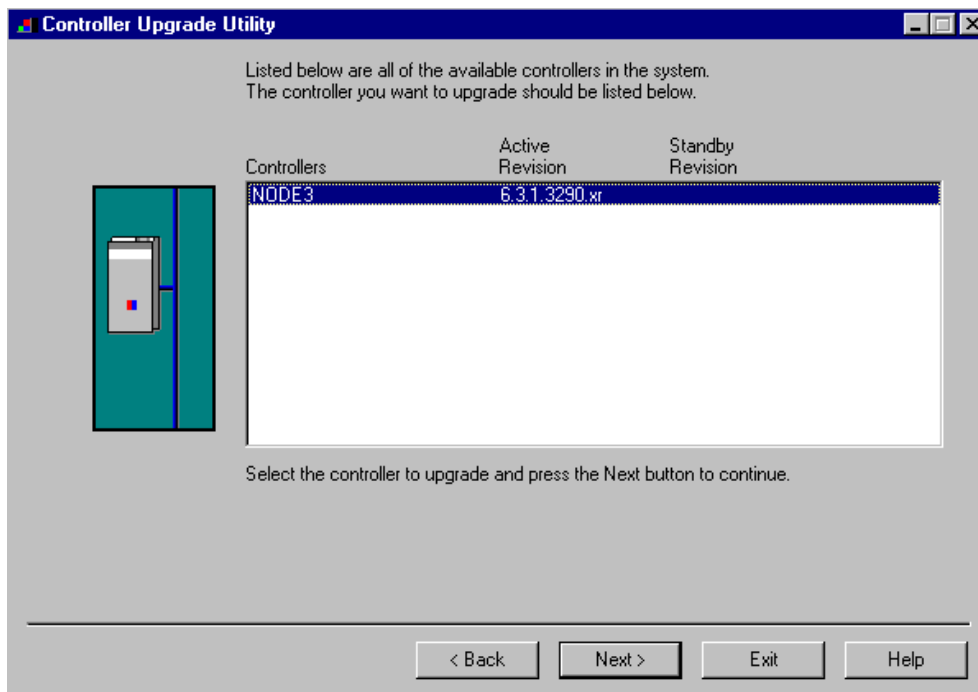

After you Click Next, the following dialog will appear, listing all the I/O modules in your selected Controller. The shown list of I/O modules is an example only. Your list will be different.

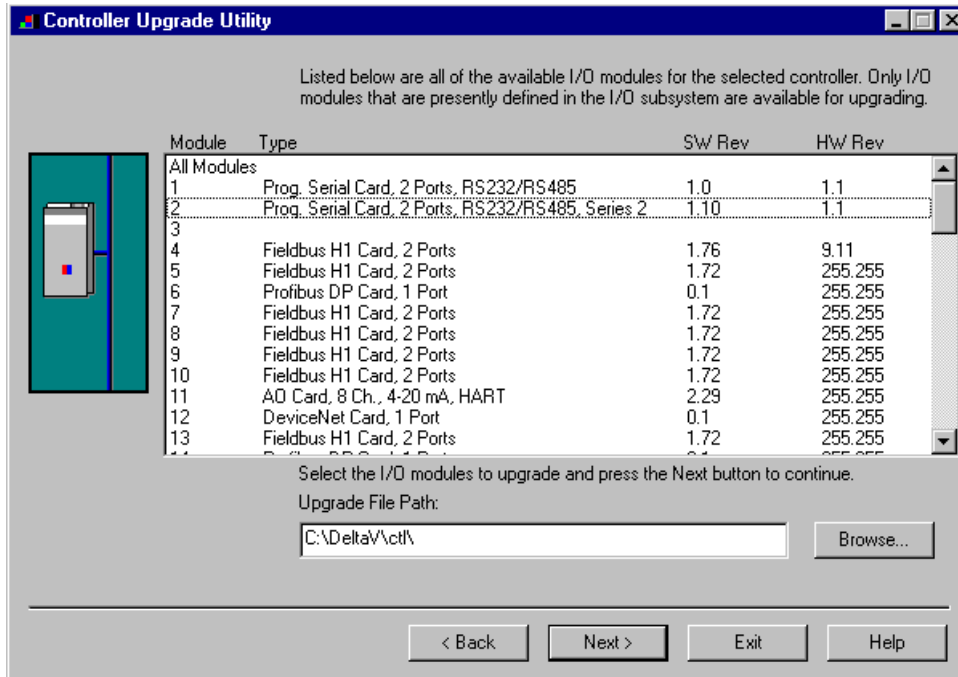

From this dialog, select the Programmable Serial Card I/O Module in the list. For example, we will select I/O Module 2. This will give you the following dialog, from which you will select the file path to where the driver software is located. This will be:

\\Delta\ct\ProgSerial\S2-1600ES

Once you are in the specified directory, you will need to select the following file:

1600ES.S2F

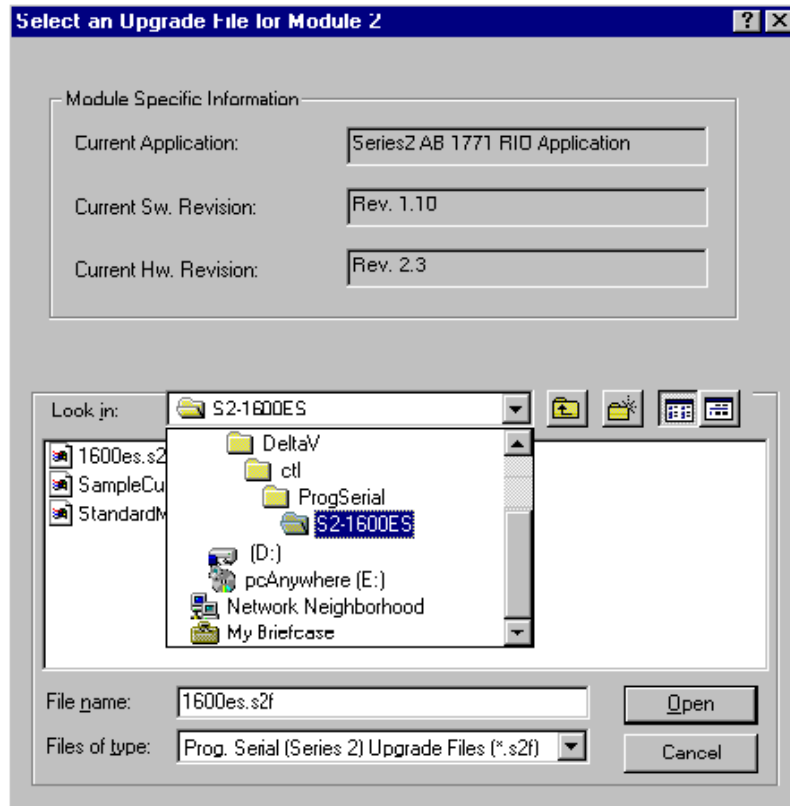

After selecting the .S2F file, Click on Open. This dialog will close and you will be back to the following:

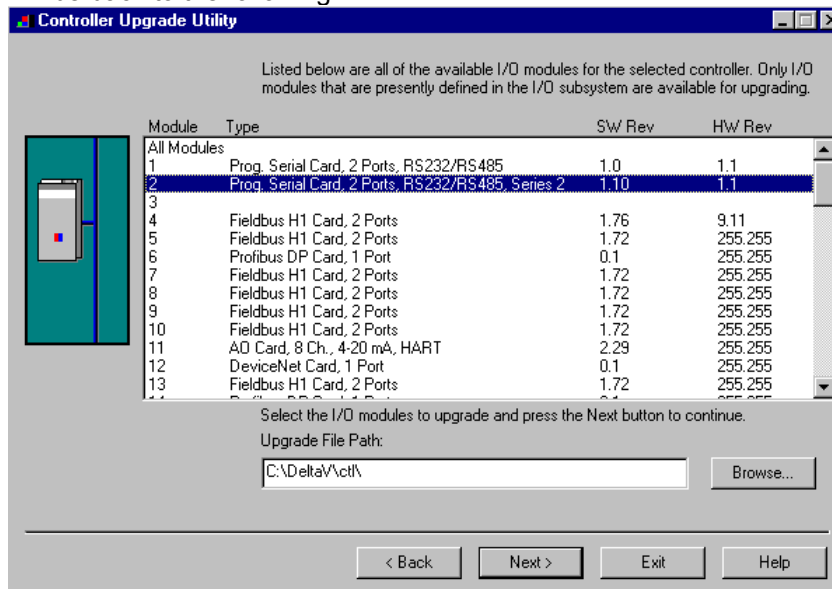

In this dialog, Click Next again. You will get the following dialog, confirming the Controller and I/O Module to program.

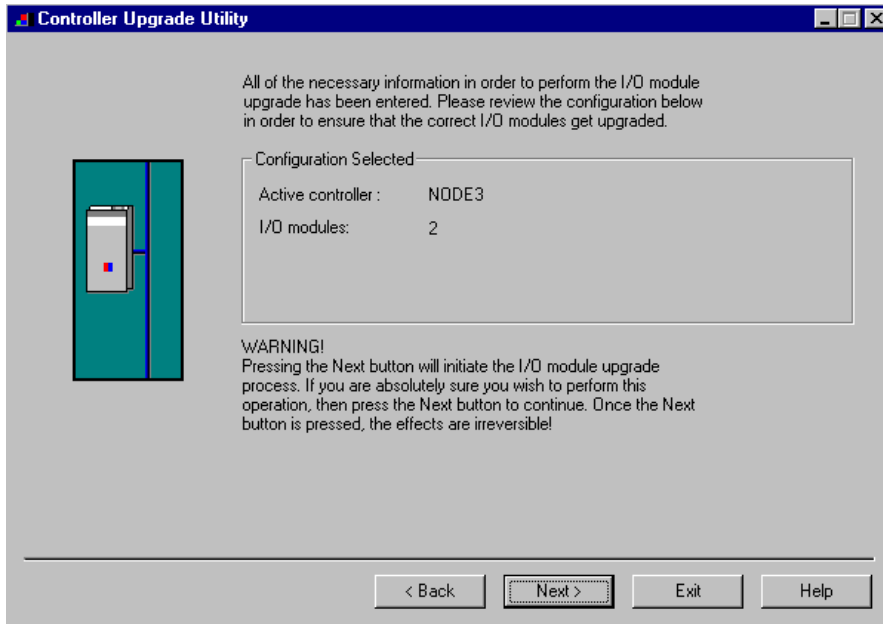

Click Next and the I/O Module upgrade process will begin. After completion, you will receive the following dialog, indicating success.

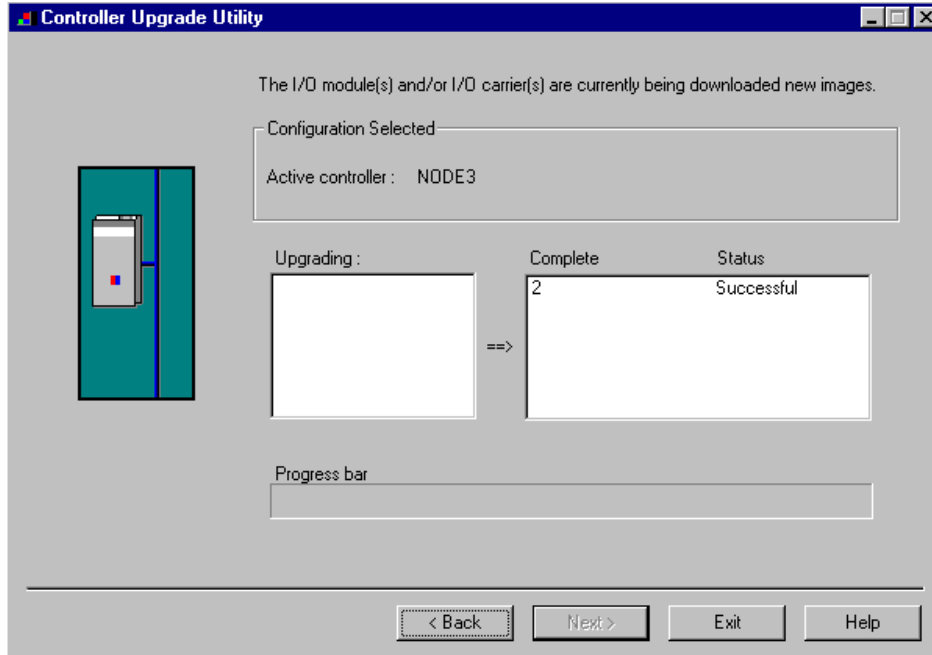

This completes the I/O Module upgrade process.



CONFIGURATION INFORMATION

The DeltaV Explorer view of a configuration containing a Programmable Serial Card will be as follows, where C01 has a card type of Programmable Serial Card, P01 and P02 are the ports on the card. The following is the default configuration for use with this driver. Each port will contain 1 device with 6 defined datasets.

Registers in each dataset will correspond to the 1600ES Port Number. For example if port 13 on the 1600ES is active:

- Date will be stored in Dataset 1 Register 13
- Time in Dataset 2 Register 13
- Carbon Dioxide in Dataset 3 register 13
- Nitrogen in Dataset 4 Register 13
- Oxygen in Dataset 5 Register 13
- Argon in Dataset 6 Register 13

This way all the Dates are in Dataset 1, the Times in Dataset 2, and so on. To gather all the information for a specific port in the 1600ES you would note the port number and look at that register in each of the 6 datasets.

Dataset Configuration
Table 3

Port	Devices	Dataset	Mode	Type and Number of Values	Description
P01					
	DEV01				
		DS1	Input	32-Bit Unsigned Int, 32 Values	Stores the 1600ES Date for each port
		DS2	Input	32-Bit Unsigned Int, 32 Values	Stores the 1600ES Time for each port
		DS3	Input	Floating Point, 32 Values	Stores the Carbon Dioxide reading for each port.
		DS4	Input	Floating Point, 32 Values	Stores the Nitrogen reading for each port.
		DS5	Input	Floating Point, 32 Values	Stores the Oxygen Reading for each port.
		DS6	Input	Floating Point, 32 Values	Stores the Argon Reading for each port.

Note – Configuration for Port P02 will be identical to Port P01.

4.1 Port Configuration

First, enable the port. Then click on the Advanced Tab and choose slave mode. In slave mode the serial card will wait for data to arrive from the 1600ES and store it in appropriately. Next, click on the Communications Tab and specify the Port type. Lastly, select the Baud rate, Parity, Data bits and Stop bits parameters; these must match the 1600ES settings.

4.2 Device Configuration

Specify devices, as shown above. There will be one device under each port.

4.3 Dataset Configuration

6 datasets will be defined under each port. The datasets will hold values as shown above in Table 3.

4.3.1 Data Direction:

All datasets will be defined as input.

4.3.2 Output Mode and Readback:

Output mode and Readback are not used in this driver and should be left as default.

4.3.3 DeltaV Data Type:

The DeltaV data type should be set as 32-Bit Unsigned Int for Datasets 1-2 and Floating Point for Datasets 3-6.

4.3.4 DeviceDataType

DeviceDataType will not be used for this driver and should be left as default.

4.3.5 Data Start Address and Number of Values

Data Start Address for datasets should be as follows:

Dataset	Data Start Address
1	0
2	100
3	200
4	300
5	400
6	500

4.3.6 Special Data

Special Data values will not be used and should be left as default.

Registers in each dataset will correspond to the 1600ES Port Number. For example if port 13 on the 1600ES is active:

5 Operational Check

5.1 Scope

The following sections provide some assistance to ensure the interface is working properly.

5.2 Verify Hardware and Software Version Number

The user can verify that the 1600ES driver has been installed using the DeltaV Diagnostics tool. The Diagnostics tool will show the Hardware Revision No. (HwRev) and the Software Revision No. (SwRev).

To begin the DeltaV Diagnostic tool select Start-> DeltaV-> Operator-> Diagnostics. In the Diagnostics tool expand the Controller, I/O and then double click on the Programmable Serial Interface Card that has the driver installed.

The following information will be displayed:

:	:	:
HwRev	Hardware Revision	1.10 (or later)
SwRev	Software Revision	2.3 (or later)

5.3 Verify Configuration

- Verify port configuration: The serial port must be enabled. User needs to make sure communication settings such as baud rate, parity, and the number of data bits match the field device settings.
- Verify dataset configuration: The datasets configured must be as shown above.

5.4 Verify I/O Communication With Control Studio

User can create I/O modules in the control studio to verify correct values are being written out. An example module is shipped with the distribution. This module shows methods for writing text to the datasets and also how to handle time.

5.5 Using Diagnostics

- Verify PSIC communication: Select the PSIC on Diagnostics and press the right mouse button. Select Display Real -Time Statistics from the drop down menu. If the Programmable Serial Interface Card is functioning then the user will see the Valid Responses counter and the Async and/or Sync Transactions counters incrementing. There will not be any error counting up.



Powerful Solutions for Digital Plants

- Verify port statistics: Select the Port on the Programmable Serial Interface Card and press the right mouse button. Then select Display Port Statistics from the drop down menu. Verify that the port communications statistics are being displayed properly and are counting as expected for the protocol's functionality.
- Verify dataset values: Select a dataset and press the right mouse button. Select View Dataset Registers from the Drop down window. Verify that the dataset values are displayed as expected.

5.6 LED Indication

The Yellow LED for the port should be on solid when all communications on that port are valid. The Yellow LED should be blinking if there is some valid communications and some communications with errors on that port. The Yellow LED should be OFF if there are no valid communications on that port.



DeltaV–Field Device Electrical Interface

The electrical interface between DeltaV and field devices conforms to the RS-232 and RS-422/485 standards.

Each PSIC has 2 ports, which function independently. The distance between the serial card and the field device can be as much as 5000 feet, per the RS-422/485 standard. When using RS-232, the distance is limited to 50 feet. Section 6.1 shows the pin assignments for the PSIC serial terminal block.

6.1 Pin Assignments for DeltaV PSIC

RS-232 Standard

Table 6

Terminal Number	Signal Description
1	Port 1 - Isolated Ground (GND)
2	Unused
3	Port 1 – Transmit Data (TxD)
4	Unused
5	Port 1 – Receive Data (RxD)
6	Unused
7	Port 1 – Data Terminal Ready (DTR)
8	Port 1 – Data Set Ready (DSR)
9	Port 2 - Isolated Ground (GND)
10	Unused
11	Port 2 – Transmit Data (TxD)
12	Unused
13	Port 2 – Receive Data (RxD)
14	Unused
15	Port 2 – Data Terminal Ready (DTR)
16	Port 1 – Data Set Ready (DSR)

RS-422/485 Half Duplex Standard

Table 7

Terminal Number	Signal Description
1	Port 1 – Isolated Ground (GND)
2	Port 1 - Data +
3	Unused
4	Port 1 - Data -
5	Unused
6	Unused
7	Unused
8	Unused
9	Port 2 – Isolated Ground (GND)
10	Port 2 – Data +
11	Unused
12	Port 2 - Data -
13	Unused
14	Unused
15	Unused
16	Unused

RS-422/485 Full Duplex Standard

Table 8

Terminal Number	Signal Description
1	Port 1 – Isolated Ground (GND)
2	Port 1 – TxD +
3	Unused
4	Port 1 – TxD -
5	Unused
6	Port 1 – RxD +
7	Unused
8	Port 1 – RxD -
9	Port 2 – Isolated Ground (GND)
10	Port 2 – TxD +
11	Unused
12	Port 2 – TxD -
13	Unused
14	Port 2 – RxD +
15	Unused
16	Port 2 – RxD -

6.2 Wiring Connections

For additional DeltaV cabling information, please refer to the DeltaV Books Online documentation. For 1600ES cabling information see appropriate 1600ES documentation.



Powerful Solutions for Digital Plants

Technical Support

For technical support or to report a defect, please give Mynah Technologies a call at (636) 681-1555. If a defect is discovered, please document it in as much detail as possible and then fax your report to us at (636) 681-1660.

For Product functionality questions, ask for the people in the following order:

1. David Story
2. Tony Kerr

For Commercial issues, ask for people in the following order:

1. Martin Berutti
2. Jane Wagner

You can also send us your questions via e-mail. Our address is:

support@mynah.com

Thank you for using DeltaV.