



M Y N A HSM

**SEC 4100 SYSTEM MONITOR
Programmable Serial Interface Card
Series 2**

USER MANUAL

Rev. P1.11

September 13, 2006

DeltaV is a trademark of Emerson Process Management, Inc © Emerson Process Management, Inc. 1998, 1999. All rights reserved.

Printed in the U.S.A.

While this information is presented in good faith and believed to be accurate, MYNAH Technologies does not guarantee satisfactory results from reliance upon such information. *Nothing contained herein is to be construed as a warranty or guarantee, express or implied, regarding the performance, merchantability, fitness or any other matter with respect to the products, nor as a recommendation to use any product or process in conflict with any patent.* MYNAH Technologies reserves the right, without notice, to alter or improve the designs or specifications of the products described herein.



1 INTRODUCTION

1.1 Scope

This document is User Manual for the SEC 4100 communications driver firmware for the Emerson Process Management (EPM) DeltaV Control System. The driver runs on the DeltaV Series 2 Programmable Serial Interface Card (PSIC). The reader should be familiar with EPM's DeltaV PSIC and connected SEC 4100 devices.

1.2 Document Format

This document is organized as follows:

Introduction	Describes the scope and purpose of this document.
Theory of Operation	Provides a general functional overview of the SEC 4100 Driver.
Downloading Firmware	Describes downloading procedures for the driver firmware on to the DeltaV PSIC.
Configuration Information	Describes procedures and guidelines for configuring the DeltaV PSIC.
Operational Check	Provides tips and assistance to ensure PSIC is properly setup and configured.
DeltaV–Field Device Electrical Interface	Describes the electrical interface between DeltaV and the SEC 4100 devices. Also describes the cable pin assignments for RS-232.
Technical Support	Describes who to call if you need assistance.



1.3 System Specifications

The following table lists the minimum system requirements for the driver:

Protocol Compatibility and Reference documents	The communication protocol used is the SEC 4100 RS232 Communication Protocol described in SEC 4100 manual: 71-4100C Version 020796
Software Requirements	DeltaV System Software (Release 6.3.2 or later) installed on a hardware-appropriate Windows workstation configured as a ProfessionalPlus for DeltaV Serial Interface Port License (VE4102)
Minimum DeltaV Hardware Requirements	FRSI DeltaV Serial Interface Series 2, Hardware PN: 12P2506X022 FRSI DeltaV M3, M5, MD or Series 2 MD Controller, Power Supply and 2 wide controller carrier FRSI 8 wide I/O card carrier



2 THEORY OF OPERATION

The Programmable Serial Interface Card (PSIC) has 2 ports which can be configured for RS-232, RS-422/RS-485 Half Duplex or RS-422/RS-485 Full Duplex communications with external devices.

For communications with SEC 4100 devices, the PSIC connects to the RS-232 port of the SEC 4100. A single SEC 4100 device can be connected to each PSIC port, as illustrated below.

The driver runs in Slave mode only. Each device uses a maximum of nine datasets with the gas level reading from each sensor being placed in the appropriate register of one of the first four datasets, sensor status information being placed in the appropriate register of datasets five through eight, and system status information being placed into the first register of dataset nine.

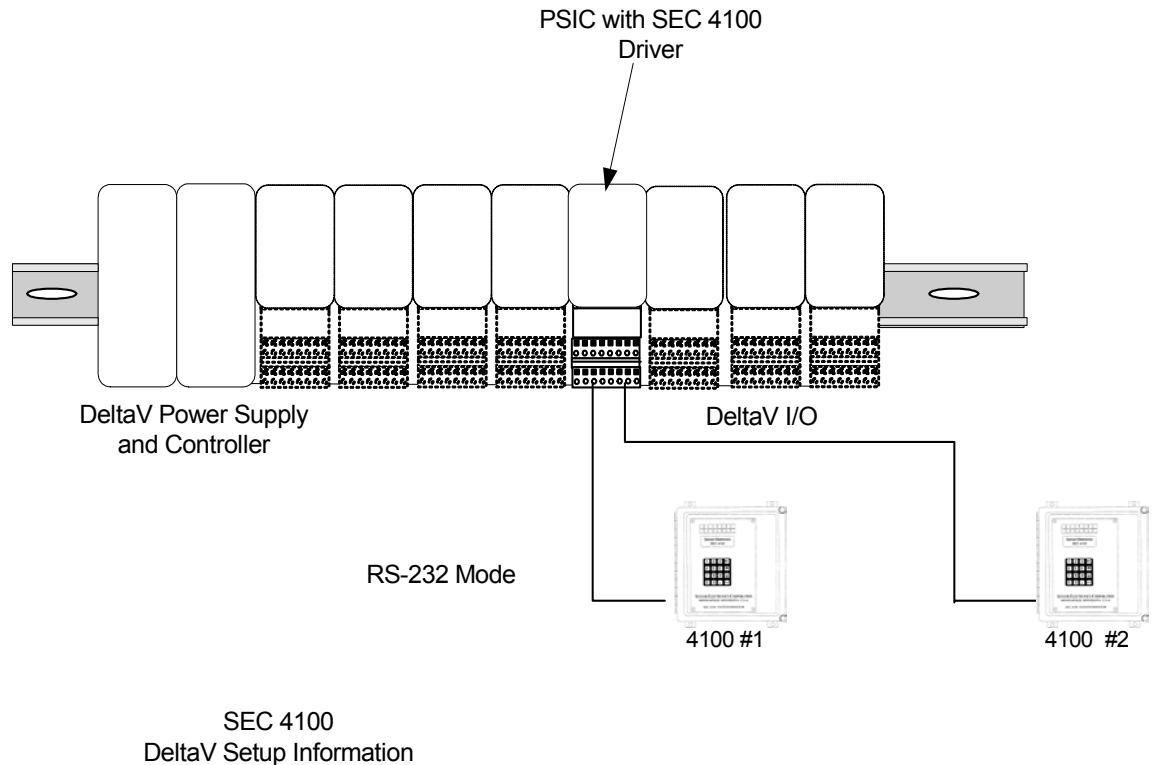



3 Downloading the firmware

The driver software distribution comprises 14 files, distributed on a CD. These files must be copied to the DeltaV directory on your ProPlus Workstation. The path is:

\\DeltaV\ctl\ProgSerial\S2-SEC4100

Note that you will have to create the \S2-SEC4100 subdirectory. The following files will be copied:

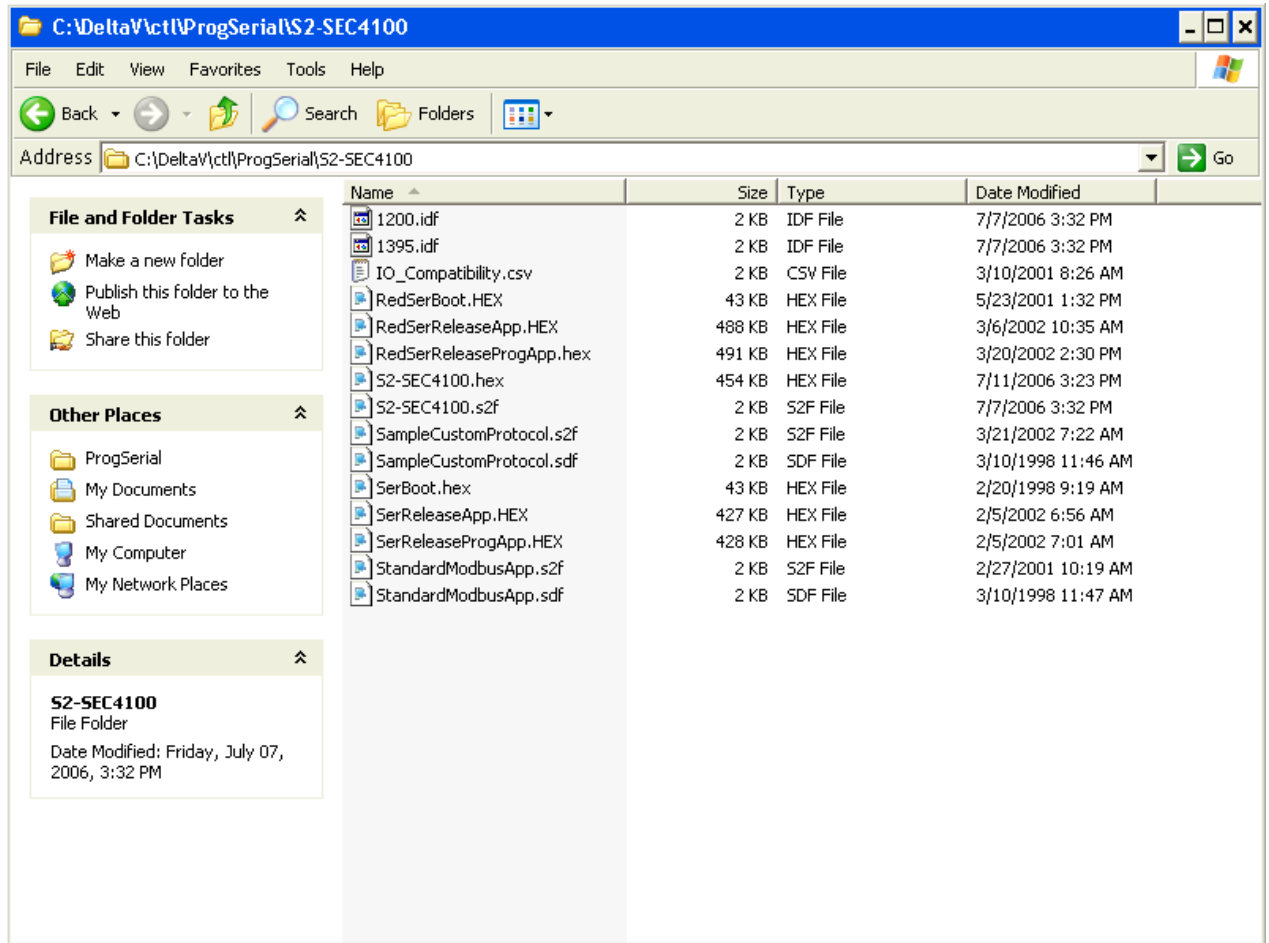



After copy completion, you are ready to program (or upgrade) the Programmable Serial Card with the supplied custom driver software. The steps are as follows:

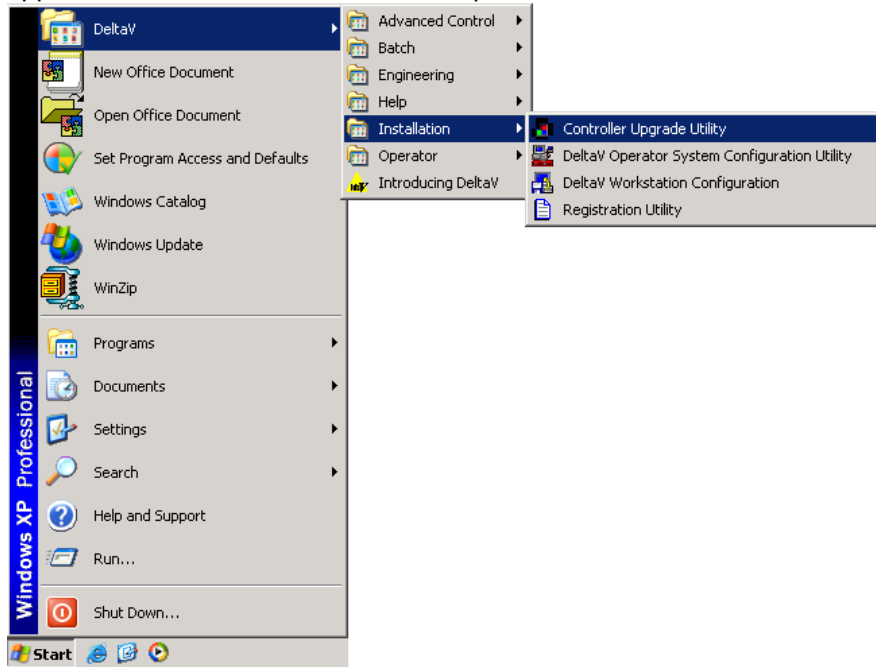

1. Click on the Start button and select DeltaV-> Installation-> Controller Upgrade Utility as shown below, and the following dialog will appear:

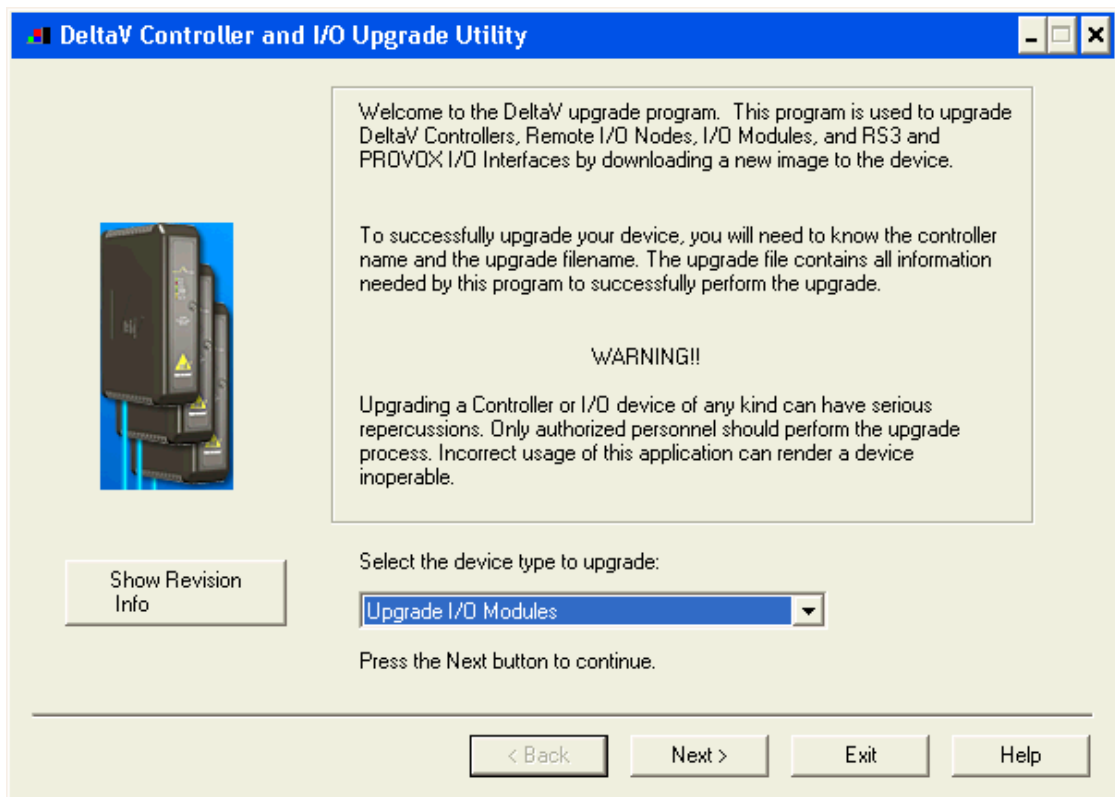

2. Choose Upgrade I/O Modules from the drop down menu and click Next.

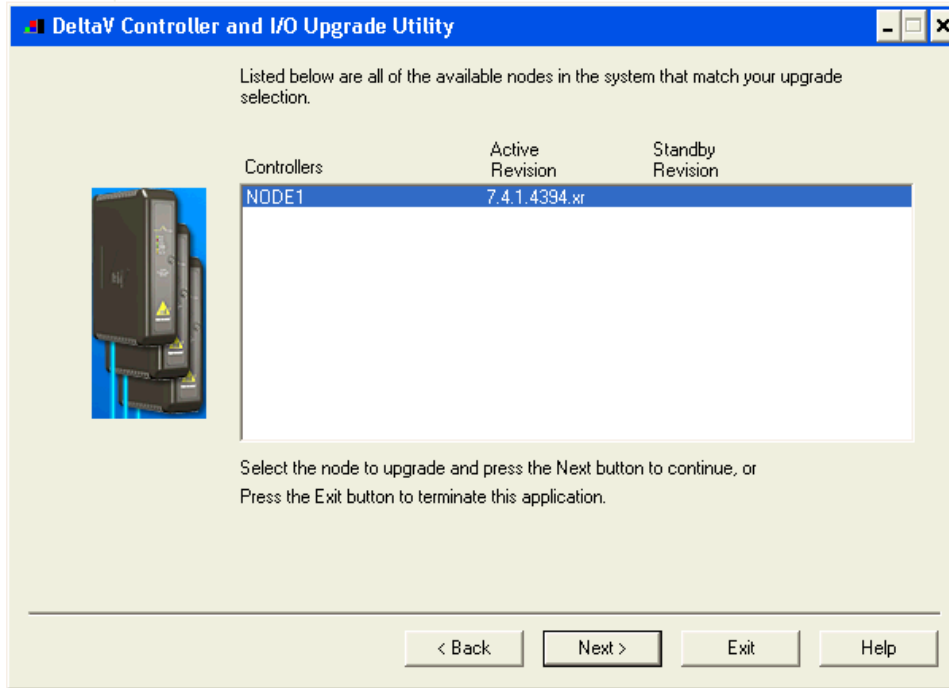

3. The above dialog will appear, listing all the available Controllers in your network. From this dialog, select the appropriate Controller and then Click Next.

4. The following dialog will appear, listing all the I/O modules in your selected Controller. The shown list of I/O modules is an example only. Your list will be different.

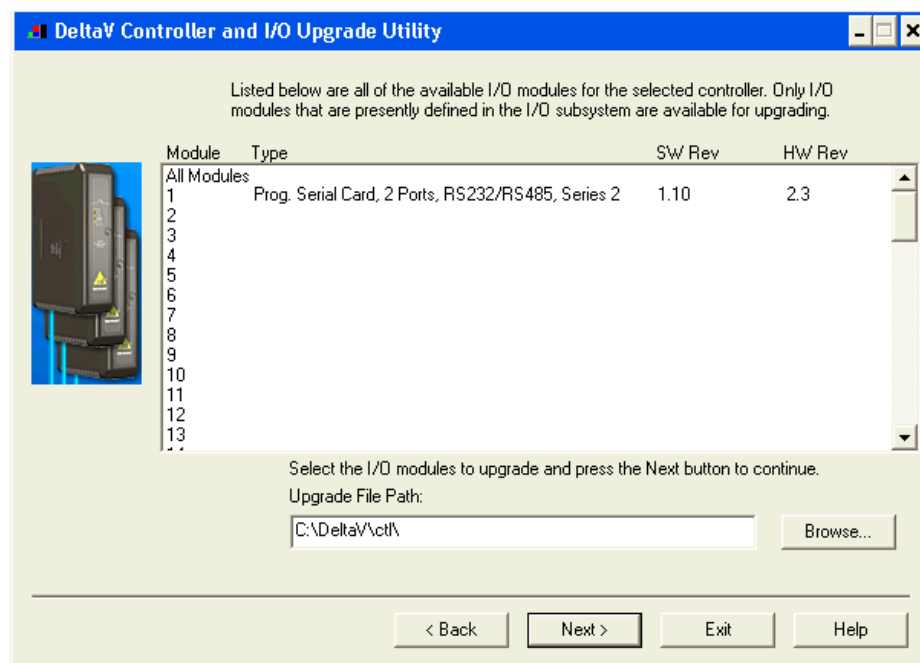



Note: The first time a standard Serial card is upgraded to the ControlNet Driver, the dialog will be as shown below. When upgrading an existing Programmable Serial Card, skip Steps 4, 5 and 6, and go to Step 7.

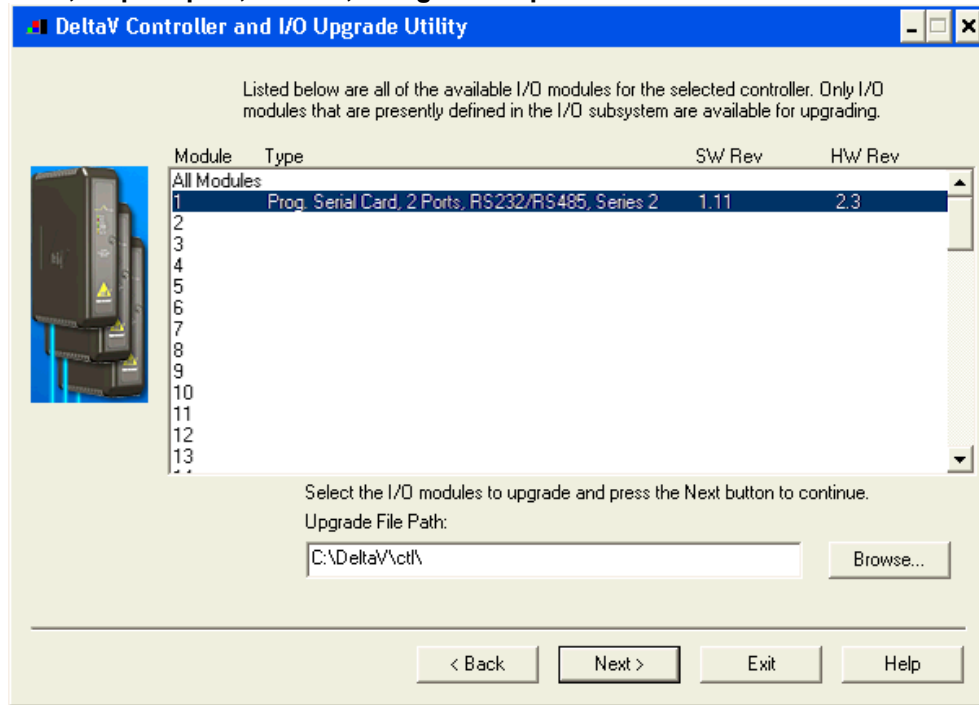

5. Click the Browse button and select the DeltaV path as shown below, and then click Ok. Note that the disk drive could be C or D.

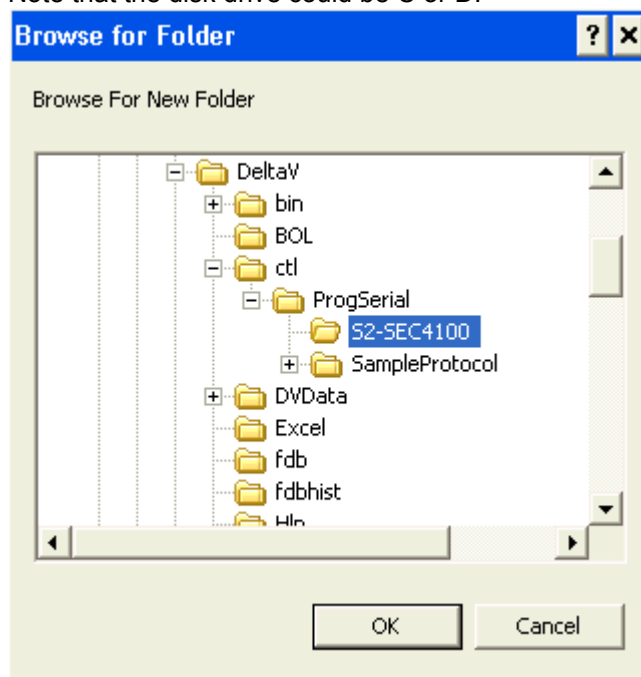



6. Select the I/O module again as shown below and then click Next. Go to Step 9.

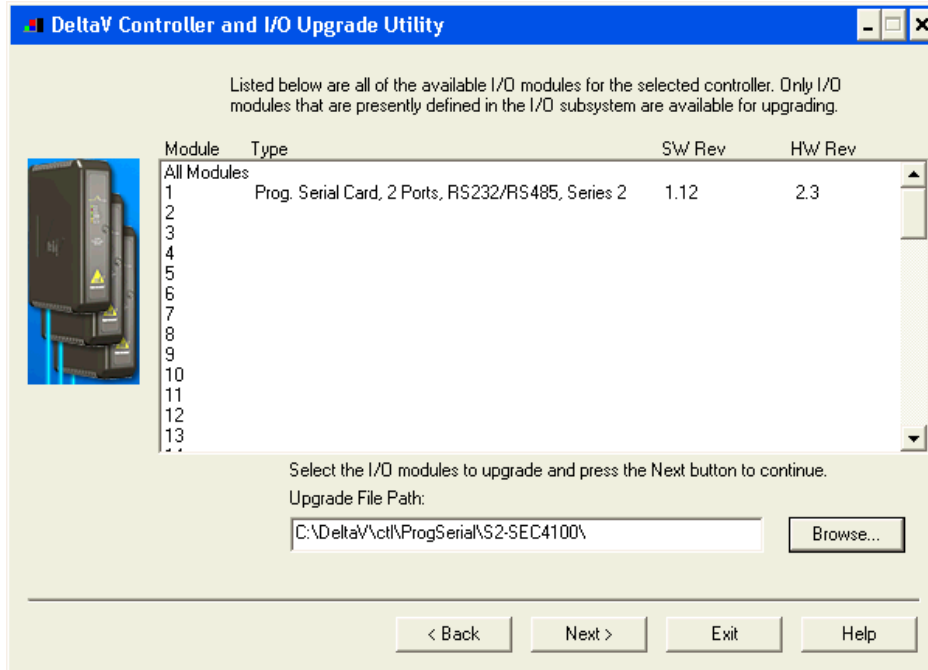

7. If you are upgrading an existing Programmable Serial Card, the dialog will be as shown below. From this dialog, select the Programmable Serial Card I/O Module in the list.

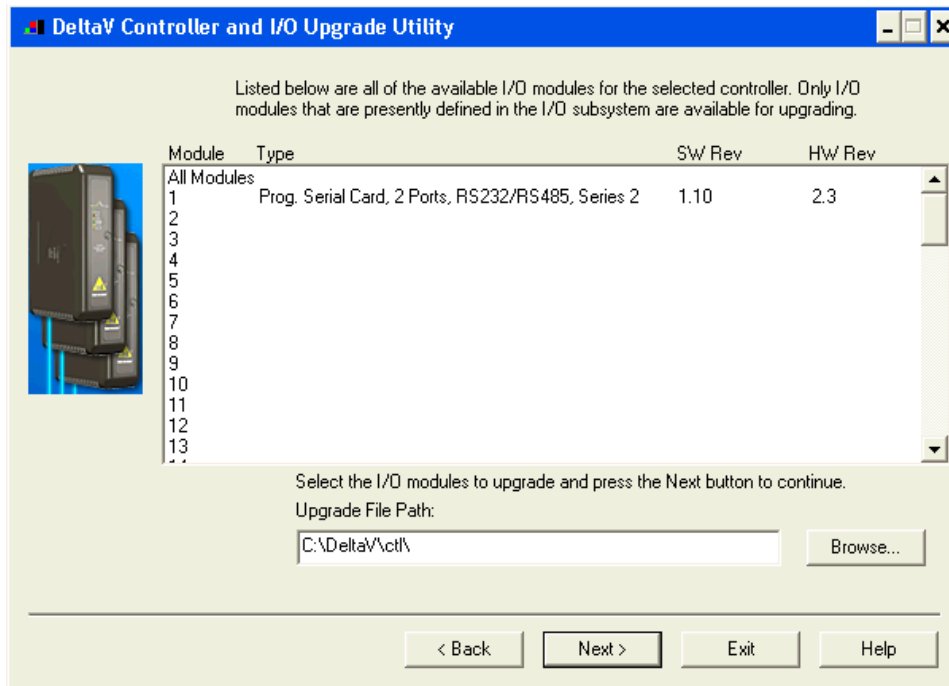



For example, we will select I/O Module 1. This will give you a dialog, from which you will select the file path to where the driver software is located. This path will be:

\\DeltaVct\ProgSerial\S2-SEC4100

Once you are in the specified directory, you will need to select the following file:

S2-SEC4100.S2F

This is shown in the following dialog.

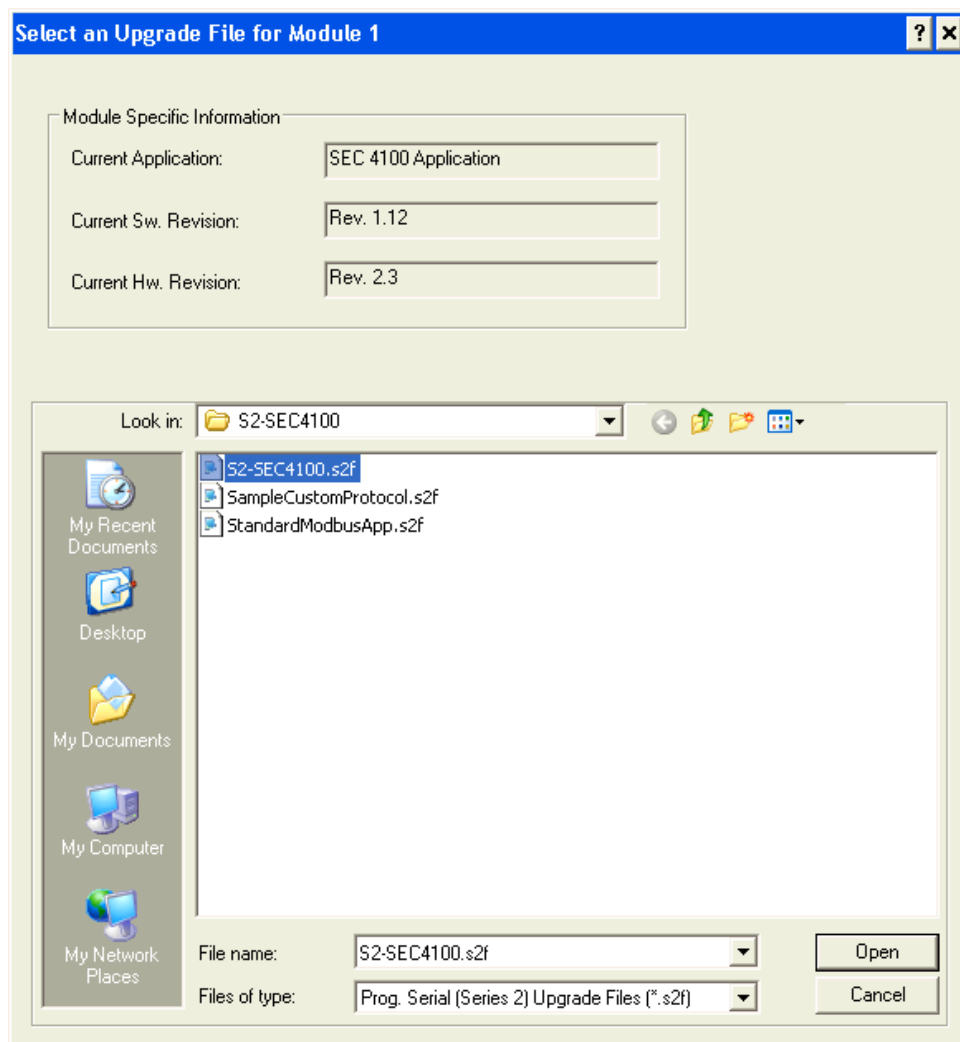

8. After selecting the .S2F file, Click on Open. This dialog will close and you will be back to the following:

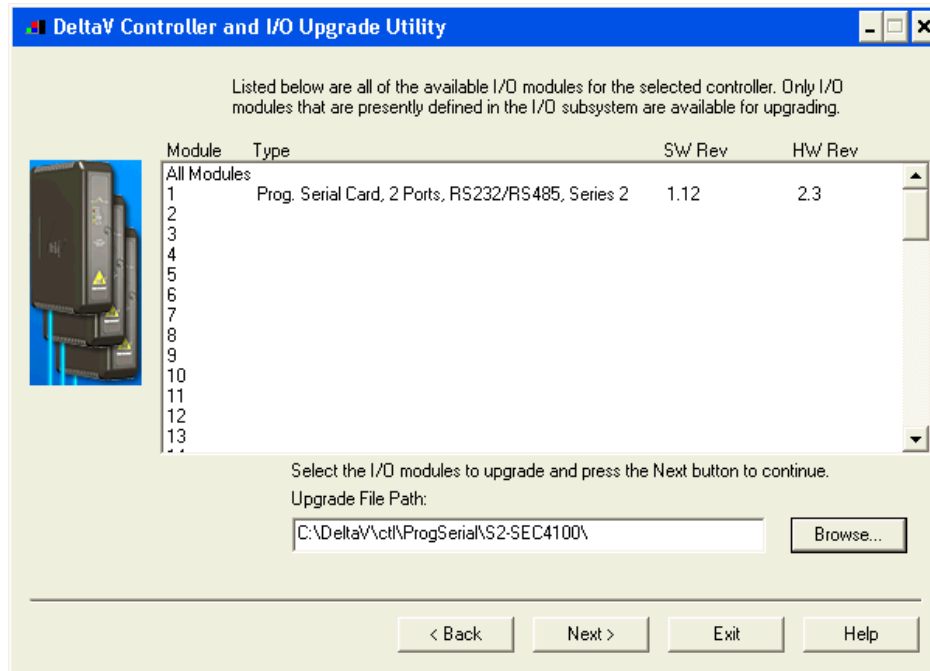

9. In this dialog, Click Next again. You will get the following dialog, confirming the Controller and I/O Module to program.

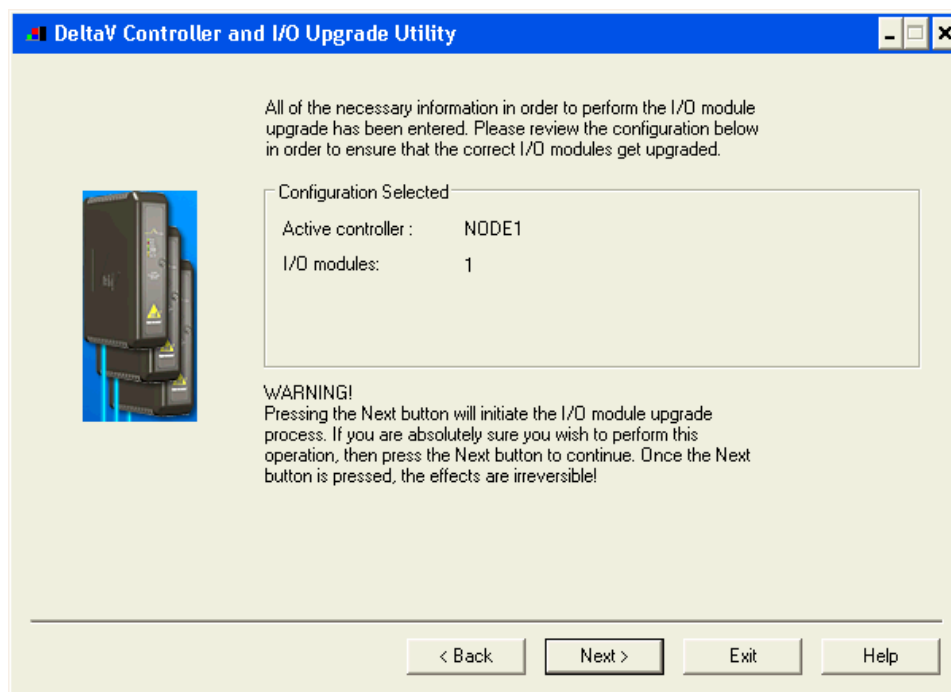

10. Click Next and the I/O Module upgrade process will begin. After completion, you will receive the following dialog, indicating success.

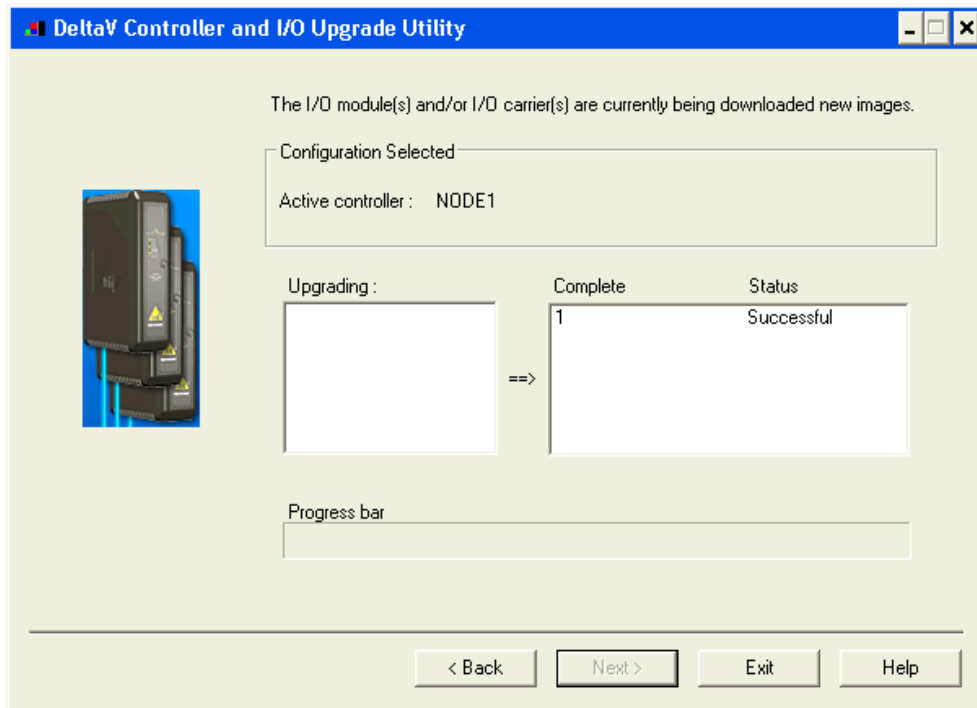

11. This completes the I/O Module upgrade process.



4.3 Dataset Configuration

4.3.1 Data Direction:

One to nine datasets are to be defined under each device. The number of datasets is determined by the device ID's of the sensors in the field. The gas level data from devices 1-100 is placed in dataset 1, data from devices 101-200 is placed in dataset 2, data from devices 201-300 is placed in dataset 3 and data from devices 301-400 is placed in dataset 4. Sensor Status data from devices 1-100 is placed in dataset 5, status from devices 101-200 is placed in dataset 6, status data from devices 201-300 is placed in dataset 7, status data from devices 301-400 is placed in dataset 8 and system status data is placed in the first register of dataset 9. If the needed dataset is not configured, the data will be lost. Since this is a slave driver, input or output does not need to be selected.

4.3.2 DeltaV Data Type, Device Data Type and Number of Values

Table 1 – Dataset Configuration

DATASET	DeltaV DATA TYPE	DEVICE DATA TYPE	DATA START ADDRESS	NUMBER OF VALUES
1-8	16-Bit UINT	0	0	100
9	16-Bit UINT	0	0	1

4.3.3 Special Data

The Special Data values (1-5) will not be used in this driver and can be left as default.

4.3.4 Register Mappings

Table 2 – Dataset Register Mapping

DATASET	REGISTER	DESCRIPTION
1	1-100	Gas Level Data for Devices 1-100
2	1-100	Gas Level Data for Devices 101-200
3	1-100	Gas Level Data for Devices 201-300
4	1-100	Gas Level Data for Devices 301-400
5	1-100	Sensor Status Data for Devices 1-100
6	1-100	Sensor Status Data for Devices 101-200
7	1-100	Sensor Status Data for Devices 201-300
8	1-100	Sensor Status Data for Devices 301-400
9	1	System Status



4.3.5 Status Registers

Datasets 5-8 contain the sensor status information. Each dataset register corresponds to a specific sensor device as shown in Table 2. The register values are as follows:

Table 3 – Sensor Status Values

STATUS VALUE	DESCRIPTION
0	OK
1	OFL – Offline
2	FLT – Fault
3	L – Low Alarm
4	M – Middle Alarm
5	H – High Alarm
6	HH – High High Alarm
7	CAL – Calibration Mode

Dataset 9 contains the system status information. Only one register is used as follows.

Table 4 –System Status Values

STATUS VALUE	DESCRIPTION
0	OK
1	LB – Line Break



5 Operational Check

5.1 Scope

The following sections provide some assistance to ensure the interface is working properly.

5.2 Verify Hardware and Software Version Number

The user can verify that the SEC 4100 driver has been installed using the DeltaV Diagnostics tool. The Diagnostics tool will show the Hardware Revision No. (HwRev) and the Software Revision No. (SwRev).

To begin the DeltaV Diagnostic tool select Start-> DeltaV-> Operator-> Diagnostics. In the Diagnostics tool expand the Controller, I/O and then double click on the Programmable Serial Interface Card that has the driver installed.

The following information will be displayed:

:	:	:
SwRev	Software Revision	1.10 (or later)
HwRev	Hardware Revision	2.3 (or later)

5.3 Verify Configuration

- Verify port configuration: The serial port must be enabled. It must be set to Slave mode. User needs to make sure communication settings such as baud rate, parity, and number of data bits match the SEC 4100 settings.
- Verify Dataset configuration: up to nine datasets, which contain 100 16-bit UINT registers.

5.4 Verify I/O Communication With Control Studio

- User can create I/O modules in the control studio to verify correct values are read and written between the foreign device into the PSIC. For input data, the values should be changed in the foreign device and verified that the new data are correctly reported. For output data, change the values in the controller and then verify that the values are transferred to the foreign device.
- To assign a Dataset and a register in the Dataset to an I/O module, follow these steps:
 1. Double click the IO_IN/IO_OUT parameter for the module. This brings up the IO_IN/IO_OUT Property window.
 2. Click on the Browse button. This brings up the Browse window.
 3. Click on the Object_Type drop down list, select All. This displays all the Dataset tags.
 4. Double click on the desired Dataset tag. This assigns the tag to the module and closes the Browse window.
 5. Choose the desired register in the Parameter drop down list.
 6. Click the OK button.
- For output modules, user also needs to change the MODE parameter to Manual for Normal Mode and Target.

5.5 Using Diagnostics

- Verify PSIC communication: Select the PSIC on Diagnostics and press the right mouse button. Select Display Real -Time Statistics from the drop down menu. If the Programmable Serial Interface Card is functioning then the user will see the Valid Responses counter and the Async and/or Sync Transactions counters incrementing. There will not be any error counting up.
- Verify port statistics: Select the Port on the Programmable Serial Interface Card and press the right mouse button. Then select Display Port Statistics form the drop down menu. Verify that the port communications statistics are being displayed properly and are counting as expected for the protocol's functionality.
- Verify dataset values: Select a dataset and press the right mouse button. Select View Dataset Registers from the Drop down window. Verify that the dataset values are displayed as expected.

5.6 LED Indication

The Yellow LED for the port should be on solid when all communications on that port are valid. The Yellow LED should be blinking if there is some valid communications and some communications with errors on that port. The Yellow LED should be OFF if there are no valid communications on that port.

6 DeltaV–Field Device Electrical Interface



The electrical interface between DeltaV and field devices conforms to the RS-232 and RS-422/485 standards.

Each PSIC has 2 ports. The SEC 4100s operate in RS-232 Full-Duplex mode only. If RS-485 is required for distance, the appropriate converter must be used.

6.1 Pin Assignments for DeltaV PSIC

RS-232 Standard

Table 7

Terminal Number	Signal Description
1	Port 1 – Isolated Ground (GND)
2	Unused
3	Port 1 - TXD
4	Unused
5	Port 1 - RXD
6	Unused
7	Port 1 - DTR
8	Port 1 - DSR
9	Port 2 – Isolated Ground (GND)
10	Unused
11	Port 2 - TXD
12	Unused
13	Port 2 - RXD
14	Unused
15	Port 2 - DTR
16	Port 2 - DSR



6.2 Wiring Connections

The figure below shows the connections between the SEC 4100 RS-232 port and Port 1 on the Serial Card Termination Block.

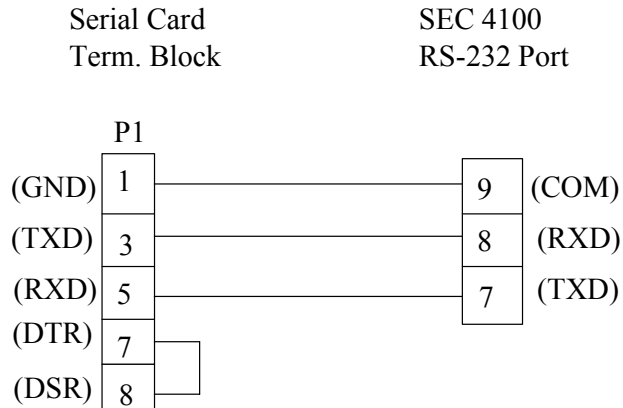



M Y N A H™

POWERFUL SOLUTIONS FOR DIGITAL PLANTS

7

Technical Support

For technical support or to report a defect, please give Mynah Technologies a call at (636) 681-1555. If a defect is discovered, please document it in as much detail as possible and then fax your report to us at (636) 681-1660.

You can also send us your questions via e-mail. Our address is:

support@mynah.com

Thank you for using DeltaV.